

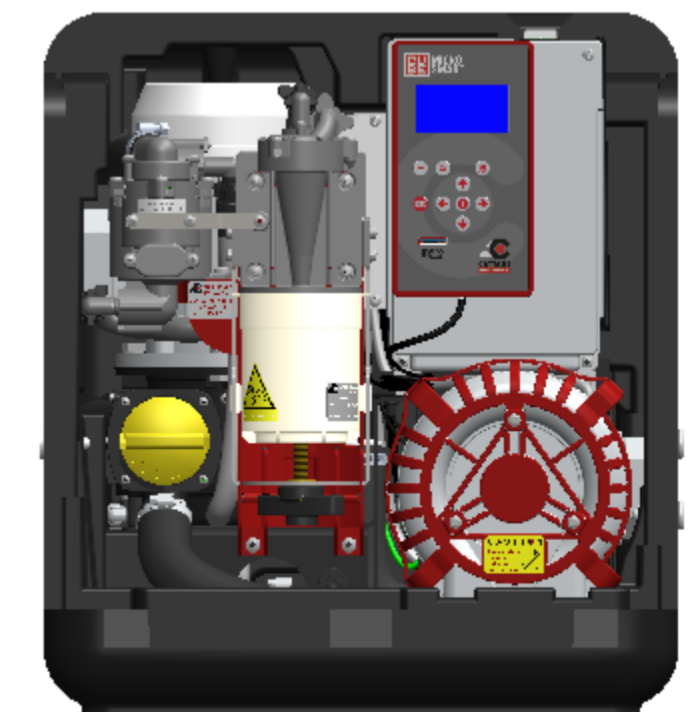

N°	Modifica	Data	Firma
04	MOD. TETTO E SPORTELLLO POSTERIORE	27/10/2016	MORTALI
03	INSERITO CENTR. IN ALLUMINIO-TOLTA AUTOESTINGUEZA MAT.	21/10/2016	MORTALI
02	MODIFICA SU SPORTELLLO ANTERIORE COD. 201332	05/10/2015	MORTALI

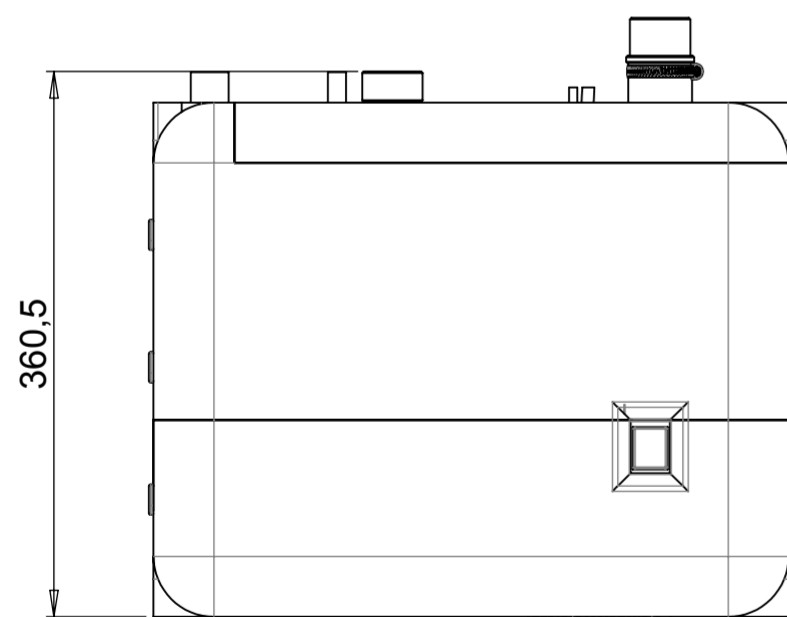
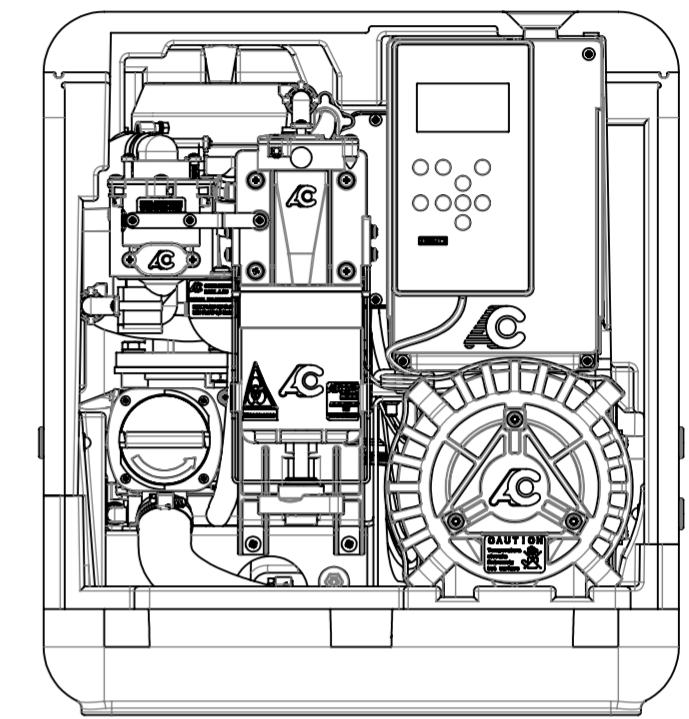
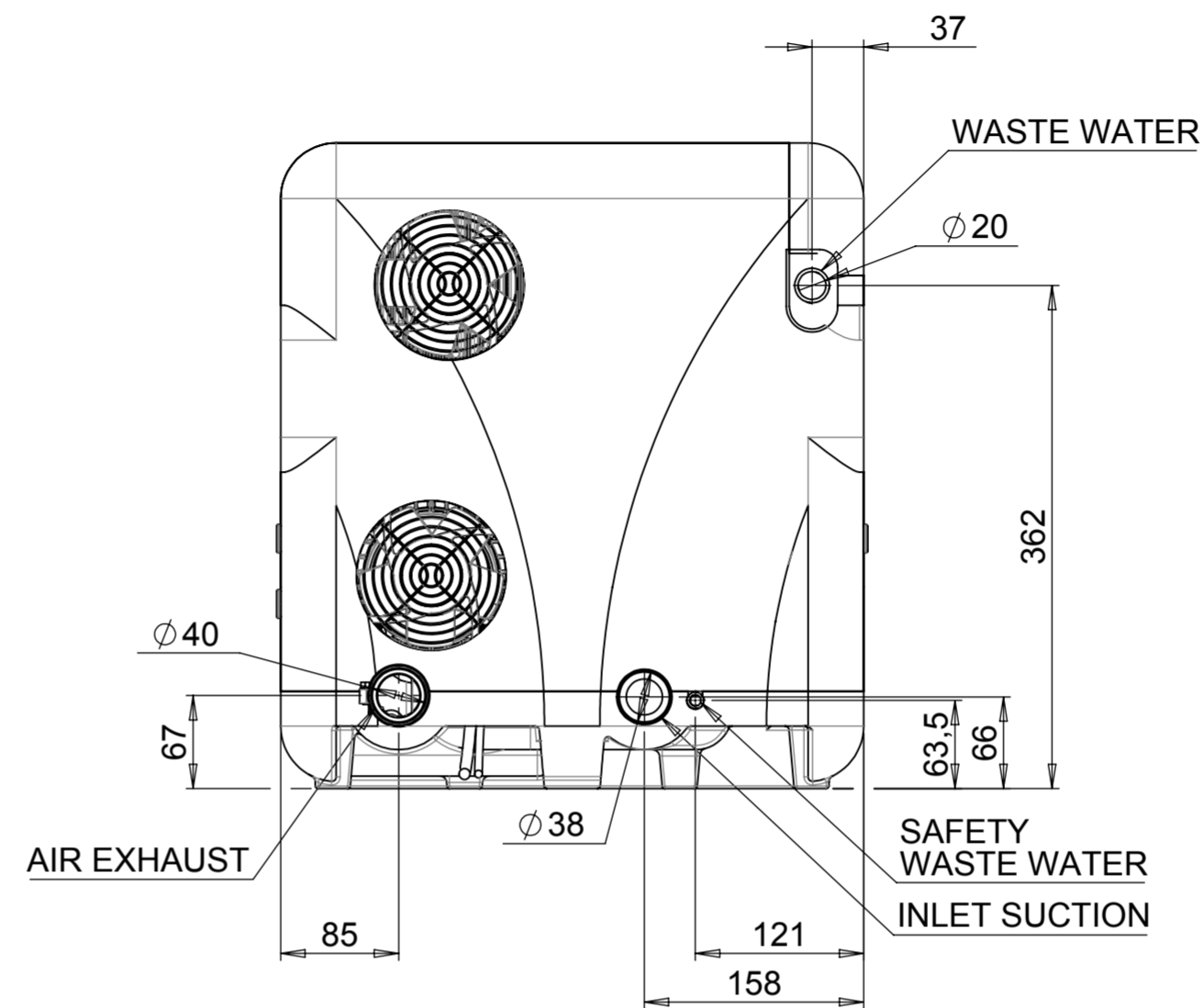
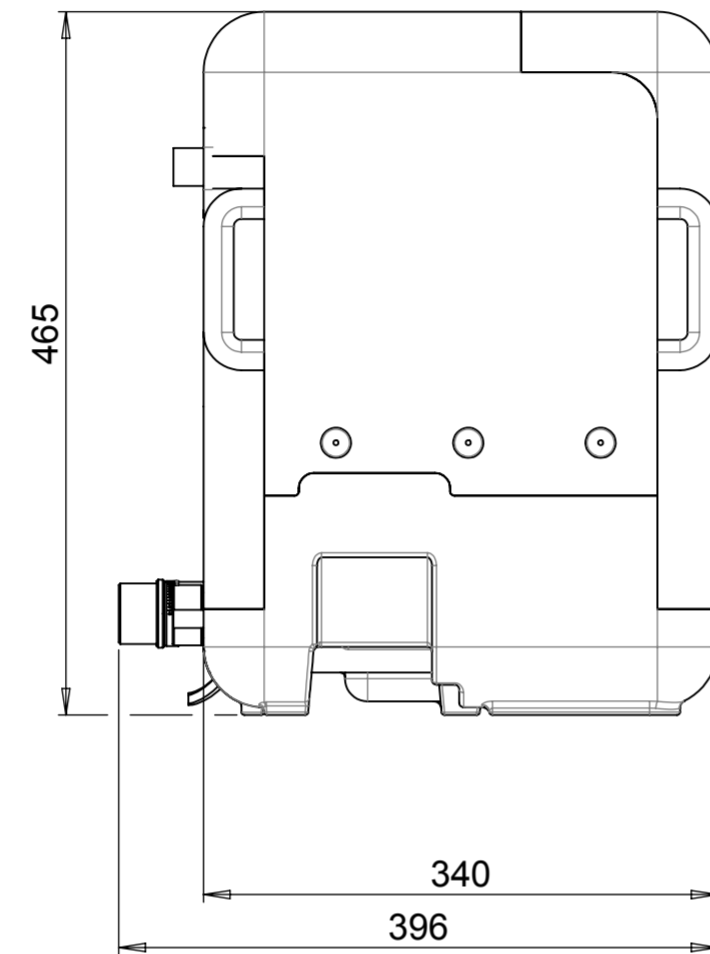
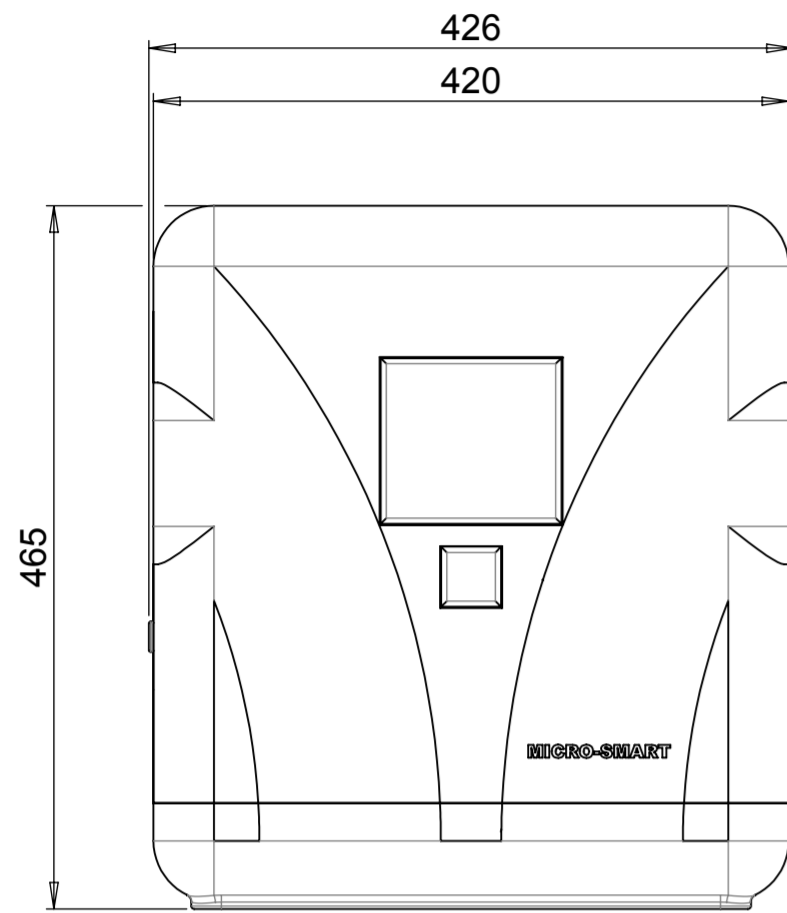

POS.	CODICE	MATERIALE GREZZO - DESCRIZIONE COMPONENTI	Q.TA'	DISEGNO NUMERO	
	DISEGNATO	APPROVATO		Peso-Kg	Modello
DATA	20/04/2015	28/10/2016			
FIRMA	MORTALI				
 Cattani S.p.A. Via Natta 6/A 43122 Parma - Italy T. +39 0521 607 604 F +39 0521 607 628 info@cattani.it www.cattani.it			Trattamenti termici e/o superficiali 0		ESEGUIRE LE QUOTE SENZA INDICAZIONE IN CLASSE DI TOLLERANZA <b>FINE</b> SECONDO UNI ISO 2768 DEL 1991 (FORI TOLLERANZA +/- ALBERI TOLLERANZA -) GOLE DI SCARICO PER PARTI DA RETTIFICA SECONDO UNI4386 FORME E/F
DENOMINAZIONE			SCALA	CODICE	
MICRO "SMART" CUBE + IDRO ISO 6			1:5	<b>035030</b>	
GRUPPO MACCHINA			DISEGNO NUMERO		
MICRO-SMART			<b>CF08-10-00</b>		