

SMART THINKING, THE WAY WE INNOVATE.



# CATTANI NEW ZEALAND

2025 CATALOGUE & PRICE LIST

VALID TO 31 DECEMBER 2025





**S**PECIALISTS IN AIR TECHNOLOGY,  
DRIVEN BY: IMAGINATION  
AND RESEARCH IN DESIGN,  
QUALITY IN PRODUCTION



### ITALIAN CRAFTSMANSHIP

Our premium air technology is the embodiment of everything that Cattani stands for. We feel a deep sense of pride when we deliver our creations, knowing its maximum reliability. Our excellent results may define us, but they also remind us of its origins – Parma, Italy.

### A REGION RENOWNED FOR QUALITY

Parma province is part of the Emilia-Romagna region, famously renowned for Parmigiano Reggiano cheese, Prosciutto di Parma, and the home of quality brands such as Ferrari, Lamborghini, Maserati, and Ducati.

Amongst the finest craftsmanship in the world, it was here that the late Prof. Augusto Cattani established Cattani in 1967 and pioneered the most advanced dental suction and air compression equipment.

After becoming a publicly limited company in 1981, Cattani S.p.A. expanded the range with the Magnolia dental consumables range, extending the group's air technology capabilities to chemical products.

Passing on the unparalleled quality and technical knowledge to the next generation of the family, Ennio Cattani, their legacy had reached partners in more than 60 countries. Among them, the Clark family in Melbourne, Australia.



## THE AUSTRALIAN LEGACY

The essence of Cattani quality was conceived in Italy and is now meticulously cultivated in the Australasian region. Our first-class service guarantees added value to the already unmatched workmanship brought to us by Italy, before delivering it to our customers. From our additional quality inspection on Australian soil, to our exclusive After Care Scheduled Service and Blueprints Training programs, we go the extra mile to strive towards achieving 100% reliability.

As in Italy, Cattani Australia is very much a family affair. Bill Clark, who founded Cattani Australia in 1987, started working in the dental industry more than 50 years ago. Bill holds a Non-Executive Board Position and is a Director, and is actively involved within the global dental industry as chair of the International Organization for Standardization (ISO) Committee.

The family's ongoing contributions extend to Bill's wife, Pam Clark, former Federal ADIA President 2006 to 2010, who was admitted as an Officer of the Order of Australia in 2017, cited for her 'Contribution to Humanity' after dedicating 6 years working with the United Nations and World Health Organisation, in development of The Minamata Treaty. Pam today actively holds roles with FDI and a Board Position on Academy of Dentistry International Foundation.

The next generation of the Clark family has also mirrored the Italian generational business tradition. In 2015, Allison Clark took up a Director and Board Position in the Company, relieving Bill after over 50 years of service. From this Board position, Allison has worked with Cattani Italy to expand the Cattani Agency into South East Asia, to grow on and from the Family legacy in Australia and New Zealand. Allison remains working an active and important strategic role from the Board.

Today, the Cattani-ESAM group specialises in premium air technology across the Asia Pacific region, under the leadership of Chief Executive Officer, Greg Fox. With 30 years' experience in the dental industry, including roles as Director of Marketing and Vice-President / General Manager of Dentsply, Greg drives company success through existing Cattani values, yet accelerates innovation to lead the way in premium air technology.

Leveraging our strong technical team and their commitment to innovation through in-house training and e-learning platform, the Cattani group of companies is well placed to continue to expand across the Asia Pacific region and set the quality benchmark in the global dental industry.

- **1967**  
Cattani is established.
- **1981**  
Cattani becomes a publicly limited company.
- **1987**  
Cattani Australia is established.
- **1993**  
NASA appoints Cattani-ESAM as compressor supplier.
- **c. 1997**  
Eurostar Italia train pressurisation project.
- **2003**  
Magnolia range launched.
- **2005**  
SMART Suction introduced.
- **2015**  
SMART Cube range introduced.
- **2019**  
Blueprints training program.
- **2020**  
ADIA Education Award.
- **2022**  
Turbo SMART HP launched.
- **2023**  
AFTER CARE Online launched.



*“All this painstaking care for our work. . . are justified by the results achieved. Quality needs to be sought with determination and must be scrupulously adhered to thereafter. We cannot afford to stop, as progress is unstoppable.”*

Prof. Augusto Cattani, Founder of Cattani

### QUALITY – AIR TECHNOLOGY SPECIALISTS

The ownership of Cattani equipment makes a bold statement about the dental care professionals: They are quality driven and have the highest expectations for optimal performance, precision, and reliability.

#### INNOVATION

Innovation goes hand in hand with quality. Cattani Italy prides itself in a long history of “intelligent” suction systems and compressors, from automatic operation to variable motor speed, intuitive power output (inverter control), noise reduction, and the development of suction system with a 50% reduction on raw materials.

At Cattani Australasia, we follow the Cattani Italy example, but we also take initiative. We not only lead the way in modular installation of parallel units, but with an internal technical team we can promptly respond to market demands with in-house product development.

#### EXPERTISE

We are the avant-garde, the resilient, the relentless, who are passionate about innovation and breaking new ground. With more than 50 years in the business, hailing from a region of engineering excellence, the home of Ferrari engineering, Cattani has built a global reputation in its world class craftsmanship. Don't just take our word for it. The Cattani-ESAM group was commissioned to supply air compression technology on the NASA space shuttle and the pressurisation of Eurostar Italia trains.

Cattani quality doesn't just happen. It is developed and meticulously refined over time, as Cattani leaves nothing to chance. When we specialise in one field only – air technology, the expected result is precision and mastery.

#### SERVICE

Cattani truly believes in overperforming to reach a superior level of distinction. Our commitment to equipment reliability is demonstrated through our quality assurance inspection that happens not once, but twice. The first assessment with our Italian manufacturers, then an additional physical inspection by our Australian quality assurance team.

This level of exclusivity is reinforced by our in-house local technical team, the frontrunners of the company who developed our After Care Scheduled Service and Blueprints training programs.

#### PERFORMANCE

Human centricity is key. We think and work in a holistic manner to create genuine benefits for our customers. Our market leading 7-year warranty in compressors, full parts and labour, means a peace of mind knowing your surgery has the support of our in-house technical team.

With energy savings of between 30 percent and 50 percent, a reduction in half the perceived noise through our acoustic housing, our ISO certified air solutions offer precision in dentistry, where it is paramount. Therefore, you can expect precision as an integral part of Cattani performance.



Quality and precision in air technology is the cornerstone of our values, and it is deep-rooted in the pride of Italian quality performance. It is no wonder Ferrari Engineering approached us for what was to become one of our most important ventures.

Our involvement in the space project began in the spring of 1993, when the late Professor Augusto Cattani was approached about the possibility of building a miniature compressor to be installed on board the NASA space shuttle.

With a limited storage space of merely a few centimetres, Ferrari Engineering as the supplier to the European Space Agency, recognised the enormous challenge for us, but showed absolute confidence and support in our capabilities.

Ultimately, the European Space Agency appointed the group to build a small-scale 180gm compressor, capable of maintaining a high pressure of 38 bar. The success of the NASA project sets the benchmark for Cattani, to deliver world class air technology to your dental practice.



In this fast-moving world, there is constant pressure to improve. Thankfully, we specialise in pressure, which is evident in our partnership with Eurostar Italia (formerly Pendolino Rail).

Known for their tilting train technology, their carriages can tilt at the bends at high speeds, hence the name 'Pendolino', meaning small pendulum in Italian.

During the planning for the pressurisation of their high-speed train, many tenders were submitted by major national and international companies. But the one that came out victorious, was none other than the Cattani-ESAM group.

Since then, we have developed successful partnerships globally, due to our unparalleled focus on delivering premium air technology. We don't fall under pressure, we evolve.



At Cattani Australasia, sustainability is more than a goal—it’s a responsibility. Guided by our “Connected for Good” initiative, we are committed to driving meaningful environmental change. From achieving carbon neutrality to advancing amalgam retention and energy efficiency, our approach to sustainable manufacturing demonstrates our dedication to a greener future.

Our efforts include offsetting 100% of our carbon emissions, while supporting impactful projects like Traditional Land Management and Biodiversity Conservation. Our Hydrocyclone Amalgam Retention system sets the benchmark in amalgam separation, operating seamlessly within existing SMART systems without additional power or noise. Additionally, our SMART suction systems are designed to deliver energy-efficient performance, reducing environmental impact without compromising functionality.

With a focus on recyclable materials and innovative solutions, our Turbo SMART Cube reduces raw material use by 13 kg per unit, reflecting our commitment to sustainable manufacturing.



Discover how these initiatives are shaping the future of dental air technology by visiting our website and joining us on this journey. Together, we’re connected, for good.



# TABLE OF CONTENTS

COMPRESSORS	
Introduction	08
Products	10
COMPRESSORS – LARGE PLANT	
Introduction	22
Products	24
COMPRESSORS – CAD/CAM	
Introduction	28
Products	30
COMPRESSOR ACCESSORIES AND SERVICE KITS	
Compressor Accessories	39
Compressor Service Kits	41
Compressor Spare Parts	41
SMART SUCTION	
Introduction	42
SMART Cube	44
Inverter Technology	45
Amalgam Retention	46
Products	47

LARGE PLANT SOLUTIONS	
Introduction	70
Products	72
COMPACT PLANT SOLUTIONS	
Introduction	80
Products	82
CLASSIC SUCTION	
Introduction	84
Products	85
SUCTION ACCESSORIES AND SERVICE KITS	
Suction Accessories	92
Suction Service Kits	99
Suction Spare Parts	102
CONSUMABLES – MAGNOLIA	
Introduction	104
Products	106
SELECTION, INSTALLATION, MAINTENANCE AND SERVICE	
Introduction	118
Equipment Installation	120

## PRODUCT SELECTION GUIDE



COMPRESSORS



SUCTION

1-2 CHAIRS	2-3 CHAIRS	3-4 CHAIRS	5-6 CHAIRS	7-8 CHAIRS	12+ CHAIRS
PAGE 10-11 PAGE 82	PAGE 12-13 PAGE 82	PAGE 14-15 PAGE 82	PAGE 16-19	PAGE 20-21	PAGE 24-27
PAGE 47-50 PAGE 82	PAGE 51-54 PAGE 82	PAGE 55-61 PAGE 82	PAGE 66-67	PAGE 68-69	PAGE 72-79

\* Product selection is provided as a guide only. To determine the requirements of your dental clinic, contact our customer service and technical team.

Recommended Retail Price: The price set out or referred to herein is a recommended price only and there is no obligation to comply with the recommendation.

Prices are valid until 31st December 2025. Prices may be changed without notice due to unforeseen increases of imported products or currency fluctuations. Cattani Australasia has a commitment to innovation and as such we reserve the right to change product specifications without notice. Please refer to our website for the most current product specifications. Product images and packaging are for illustrative purposes only, variations can occur due to the printing process of colours therefore the product you receive may not exactly correspond to the image. Some items listed are "indent only" products and are subject to our "Forward Order and Indent Item Policy." Please contact your Cattani Business Development Manager or our Customer Service Team for further information.

# OIL-FREE DENTAL COMPRESSORS



## PURE RELIABILITY

Cattani users make a bold statement with their purchase: they have the highest expectations for quality, performance, precision, and reliability. This is a purchasing decision that we would always want you to reflect on with complete satisfaction.

To guarantee that, we provide you a market leading 7-year warranty on our compressors, including full parts and labour.

### MORE THAN 50 YEARS IN PREMIUM AIR TECHNOLOGY

With more than 50 years of innovative contributions to the global dental industry, we provide expertise and specialisation in air technology.

### IT'S NOT JUST EQUIPMENT, IT'S AN INVESTMENT

We believe in our equipment so much that we offer a 7-year warranty on all our compressors. We'll take the chance, so you don't have to.

### DENTAL GRADE HYGIENE

Cattani compressors produce quality dental grade air by removing 99.975% of particles down to 0.3 micron. Air is then preserved in a dual coated compressor tank lined with a food grade resin and Biocote® silver ion for antimicrobial protection. Cattani compressed air quality is supported by an ISO 8573-1 standard compliance with Class 1:4:2.

### RELIABLE CATTANI COMMITMENT

We are committed to our customers enjoying their Cattani experience, from their first meeting with representatives, through technical advice before purchase, then ongoing support throughout the life of their asset.

### FUTUREPROOF CAPABILITIES

From a single chair right through to large-scale hospital and university installations, Cattani manufactures compressors in sizes and configurations suitable for every scenario.

### NOISE REDUCTION OPTIONS AVAILABLE

Where space is valuable and limited, noise can be an issue. For that, we offer a range of noise reduction options, from acoustic hoods to fully enclosed acoustic and temperature controlled cabinets.

### COMPLIMENTARY AIRLINE INSTALLATION KIT

All compressors come with an airline installation kit – a “cost saving” package to minimise installer onsite costs, and offsite tool purchasing time.



# PERFECTING DENTAL GRADE AIR DELIVERY

No matter how sophisticated our equipment are, it only makes sense to us if it produces quality results. We believe delivering dental grade quality air is a journey of innovation and improvement, hence we have spent more than 50 years meticulously refining each step of this process.



STANDARD IN ALL AC COMPRESSORS

HEPA H14  
DRYER FILTER

## 1 IT STARTS WITH THE COMPRESSOR HEAD FILTER

The primary filter ensures long-term reliability of the head unit and pistons. This component alone removes dust and particles down to 20 micron. The good news is, we're just getting started.

## 2 PIONEERING CYCLONE TECHNOLOGY

As one of the pioneers in cyclone technology within dental systems, Cattani use a highly engineered design to remove condensation and water from the air. This initiates the two-stage process in producing dry air.

## 3 ADDED FILTRATION FOR SUPERIOR QUALITY

For enhanced fine particle separation, a secondary filter disc is added to remove additional fine particles as the air exits the cyclone.

## 4 DESICCANT DRYING FOR OPTIMAL DEW POINT

The desiccant drying column uses an energy efficient passive process to absorb any remaining moisture present in the air. This final drying process ensures a humidity class 4 in line with ISO 8753-1 as stated in ISO 22052.

## 5 SINTERED BRONZE FILTER FOR ZERO MAINTENANCE

The sintered bronze filter element acts as a prelude to the HEPA H14 filter, prolonging the life of the component. More good news - the sintered bronze filter never needs replacing or cleaning.

## 6 99.975% EFFICIENCY ISO STANDARD RATING

Our antibacterial High Efficiency Particulate Air (HEPA H14) filter removes 99.975% of all particles down to 0.3 micron, before preserving the air in the Biocote® and food grade resin protected tank, ready for use.

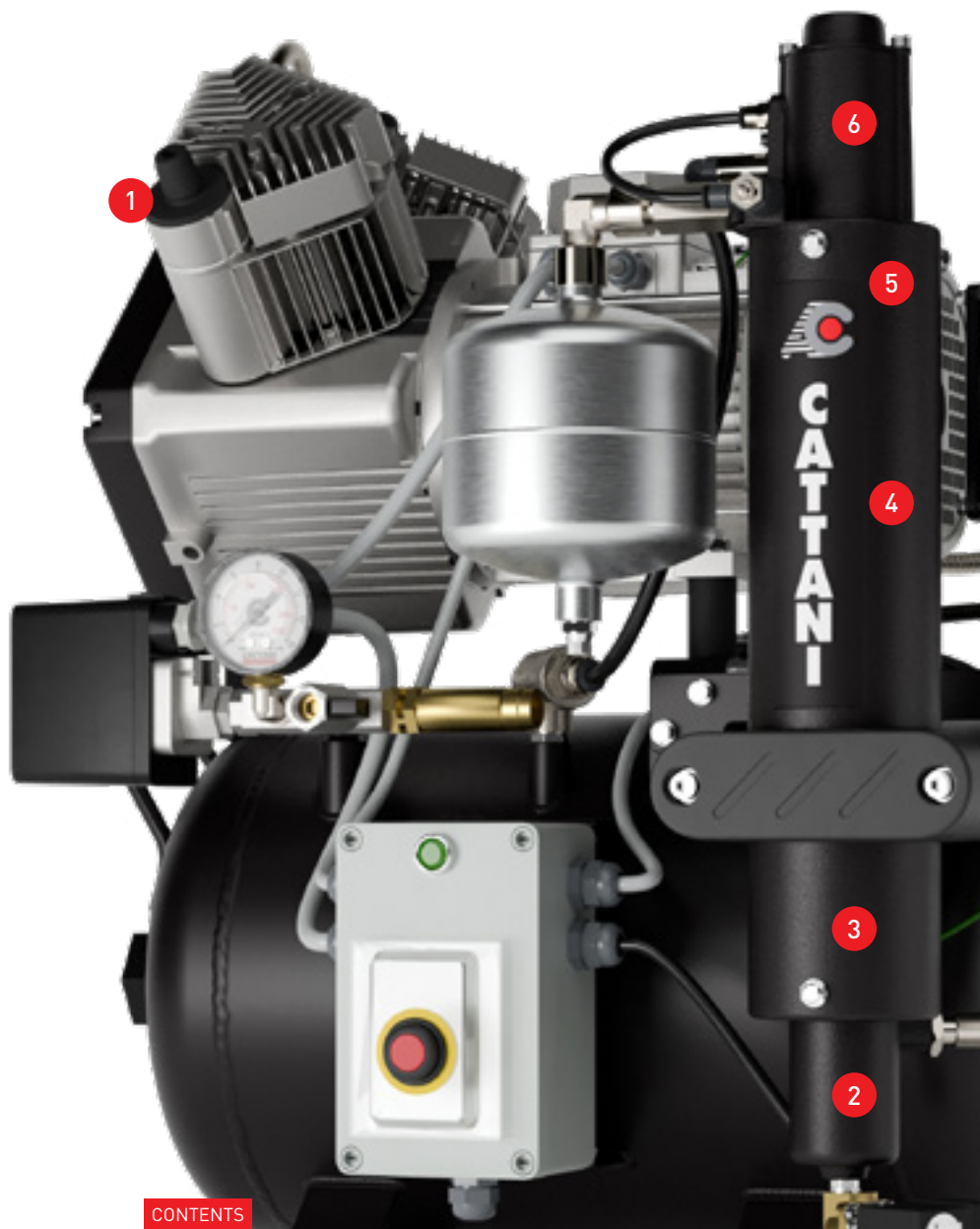

## AC100 Single Cylinder Oil-free Dental Compressor | 1 chair

The most compact of our high-performance dental compressor range, the AC100 is designed to serve 1 chair. Cattani compressors are oil-free and rigorously tested to consistently deliver clean, dry, and hygienic air.

### Details That Matter

- 7-year full parts and labour warranty
- Certified food grade resin coated tank
- Added antimicrobial protection with Biocote® silver-ion lining in tank
- Noise reduction option available (see AC100Q)
- Unrivalled technical service back-up



	AC100	AC100E
	Single Cylinder Oil-free Dental Compressor	Single Cylinder Oil-free Dental Compressor with Pre-filter
Item Code	013125	013125E
Price Ex GST	\$7,980.00	\$8,655.00
Price Inc GST	\$9,177.00	\$9,953.25
<b>SPECIFICATIONS</b>		
Power	0.55kW 3.8A 1PH 230V	0.55kW 3.8A 1PH 230V
Sound Output dB(A)	70	70
Max Air Flow at 5 Bar NL/min	67.5	67.5
Tank Size litres	30	30
<b>DIMENSIONS</b>		
Height mm	720	720
Width mm	620	620
Depth mm	460	540
Weight kg	47	47
Shipping Weight kg	65	66

### RELATED PRODUCTS



Acoustic cabinet



Compressor parallel connection kit



Service kit

**AC100Q** Quiet Single Cylinder Oil-free Dental Compressor | 1 chair

The most compact of our high-performance dental compressor range, the AC100Q is designed to serve 1 chair. Our Q series of compressors significantly reduces noise levels, making them an excellent option when equipment is close to the surgery.

**Details That Matter**

- 7-year full parts and labour warranty
- Acoustic hood for significant noise reduction
- Certified food grade resin coated tank
- Added antimicrobial protection with Biocote® silver-ion lining in tank
- Unrivalled technical service back-up



	<b>AC100Q</b>	<b>AC100QE</b>
	Quiet Single Cylinder Oil-free Dental Compressor	Quiet Single Cylinder Oil-free Dental Compressor with Pre-filter
Item Code	013144	013144E
Price Ex GST	\$10,880.00	\$11,555.00
Price Inc GST	\$12,512.00	\$13,288.25
<b>SPECIFICATIONS</b>		
Power	0.55kW 3.8A 1PH 230V	0.55kW 3.8A 1PH 230V
Sound Output dB(A)	63	63
Max Air Flow at 5 Bar NL/min	67.5	67.5
Tank Size litres	30	30
<b>DIMENSIONS</b>		
Height mm	860	860
Width mm	660	660
Depth mm	600	680
Weight kg	57	57
Shipping Weight kg	72	73

**RELATED PRODUCTS**



Ventilation fan kits



Compressor parallel connection kit



Service kit

## AC200 2 Cylinder Oil-free Dental Compressor | 2-3 chairs

One of the most popular models of our dental compressor range, the AC200 is designed to serve 2 to 3 chairs. Cattani compressors are oil-free and rigorously tested to deliver precision in hygienic air.

### Details That Matter

- 7-year full parts and labour warranty
- Certified food grade resin coated tank
- Added antimicrobial protection with Biocote® silver-ion lining in tank
- Noise reduction option available (see AC200Q)
- Unrivalled technical service back-up



	AC200	AC200E
	2 Cylinder Oil-free Dental Compressor	2 Cylinder Oil-free Dental Compressor with Pre-filter
Item Code	013208	013208E
Price Ex GST	\$8,920.00	\$9,595.00
Price Inc GST	\$10,258.00	\$11,034.25

SPECIFICATIONS		
Power	1.25kW 7.1A 1PH 230V	1.25kW 7.1A 1PH 230V
Sound Output dB(A)	71	71
Max Air Flow at 5 Bar NL/min	160	160
Tank Size litres	30	30

DIMENSIONS		
Height mm	720	720
Width mm	620	620
Depth mm	460	540
Weight kg	54	54
Shipping Weight kg	70	71

STOCKED ITEM

### RELATED PRODUCTS



Acoustic cabinet



Compressor parallel connection kit



Service kit

## AC200Q Quiet 2 Cylinder Oil-free Dental Compressor | 2-3 chairs

The AC200Q is designed to serve 2 to 3 chairs. Our Q series of compressors significantly reduces noise levels, making them an excellent option when equipment is close to the surgery.

### Details That Matter

- 7-year full parts and labour warranty
- Acoustic hood for significant noise reduction
- Certified food grade resin coated tank
- Added antimicrobial protection with Biocote® silver-ion lining in tank
- Unrivalled technical service back-up



	AC200Q	AC200QE
	Quiet 2 Cylinder Oil-free Dental Compressor	Quiet 2 Cylinder Oil-free Dental Compressor with Pre-filter
Item Code	013244	013244E
Price Ex GST	\$11,820.00	\$12,495.00
Price Inc GST	\$13,593.00	\$14,369.25
<b>SPECIFICATIONS</b>		
Power	1.25kW 7.1A 1PH 230V	1.25kW 7.1A 1PH 230V
Sound Output dB(A)	63	63
Max Air Flow at 5 Bar NL/min	160	160
Tank Size litres	30	30
<b>DIMENSIONS</b>		
Height mm	860	860
Width mm	660	660
Depth mm	600	680
Weight kg	64	64
Shipping Weight kg	81	82

STOCKED ITEM

### RELATED PRODUCTS



Ventilation fan kits



Compressor parallel connection kit



Service kit

## AC300 3 Cylinder Oil-free Dental Compressor | 3-4 chairs

One of our most popular models of the dental compressor range, the AC300 is designed to serve 3 to 4 chairs. Cattani compressors deliver high performance dry air and are completely oil-free.

### Details That Matter

- 7-year full parts and labour warranty
- Certified food grade resin coated tank
- Added antimicrobial protection with Biocote® silver-ion lining in tank
- Noise reduction option available (see AC300Q)
- Unrivalled technical service back-up



	AC300	AC300E
	3 Cylinder Oil-free Dental Compressor	3 Cylinder Oil-free Dental Compressor with Pre-filter
Item Code	013308	013308E
Price Ex GST	\$10,905.00	\$11,580.00
Price Inc GST	\$12,540.75	\$13,317.00
<b>SPECIFICATIONS</b>		
Power	1.5kW 9.2A 1PH 230V	1.5kW 9.2A 1PH 230V
Sound Output dB(A)	73.6	73.6
Max Air Flow at 5 Bar NL/min	238	238
Tank Size litres	45	45
<b>DIMENSIONS</b>		
Height mm	750	750
Width mm	620	620
Depth mm	520	600
Weight kg	65	65
Shipping Weight kg	83	84

STOCKED ITEM

### RELATED PRODUCTS



Acoustic cabinet



Compressor parallel connection kit



Service kit



**AC300Q** Quiet 3 Cylinder Oil-free Dental Compressor | 3-4 chairs

One of our most popular models of the quiet dental compressor range, the AC300Q is designed to serve 3 to 4 chairs. Our Q series of compressors significantly reduces noise levels, making them an excellent option when equipment is close to the surgery.

**Details That Matter**

- 7-year full parts and labour warranty
- Acoustic hood for significant noise reduction
- Certified food grade resin coated tank
- Added antimicrobial protection with Biocote® silver-ion lining in tank
- Unrivalled technical service back-up









**7 YEAR WARRANTY**    **OIL FREE**    **HEPA H14 DRYER FILTER**    **FOR HUMID CLIMATES**    **LOW NOISE Q RANGE**    **INCLUDES INSTALLATION KIT**

	<b>AC300Q</b>	<b>AC300QE</b>
	Quiet 3 Cylinder Oil-free Dental Compressor	Quiet 3 Cylinder Oil-free Dental Compressor with Pre-filter
Item Code	013344	013344E
Price Ex GST	\$13,805.00	\$14,480.00
Price Inc GST	\$15,875.75	\$16,652.00
<b>SPECIFICATIONS</b>		
Power	1.5kW 10.2A 1PH 230V	1.5kW 10.2A 1PH 230V
Sound Output dB(A)	68	68
Max Air Flow at 5 Bar NL/min	238	238
Tank Size litres	45	45
<b>DIMENSIONS</b>		
Height mm	979	979
Width mm	720	720
Depth mm	700	780
Weight kg	80	80
Shipping Weight kg	104	105

STOCKED ITEM

**RELATED PRODUCTS**



Ventilation fan kits



Compressor parallel connection kit



Service kit

## AC400 Tandem 2 Cylinder Oil-free Dental Compressor | 5-6 chairs

With a 100-litre tank, the AC400 is designed to serve 5 to 6 chairs, the ideal setup for a growing practice. This model is designed to deliver dry, oil-free, and hygienic air operating on three-phase power (single-phase also available).

### Details That Matter

- 7-year full parts and labour warranty
- Certified food grade resin coated tank
- Added antimicrobial protection with Biocote® silver-ion lining in tank
- Noise reduction option available (see AC400Q)
- Single-phase option available (See AC400-1P)
- Unrivalled technical service back-up



	AC400	AC400E
	Tandem 2 Cylinder Oil-free Dental Compressor	Tandem 2 Cylinder Oil-free Dental Compressor with Pre-filter
Item Code	013432	013432E
Price Ex GST	\$16,495.00	\$17,845.00
Price Inc GST	\$18,969.25	\$20,521.75
<b>SPECIFICATIONS</b>		
Power	3.0kW 7.2A 3PH 400V	3.0kW 7.2A 3PH 400V
Sound Output dB(A)	73	73
Max Air Flow at 5 Bar NL/min	320	320
Tank Size litres	100	100
<b>DIMENSIONS</b>		
Height mm	745	745
Width mm	1200	1200
Depth mm	550	610
Weight kg	112	112
Shipping Weight kg	134	136

### RELATED PRODUCTS



Ventilation fan kits



Three-phase compressor parallel connection kit



Service kit

**AC400-1P Tandem 2 Cylinder Oil-free Dental Compressor | 5-6 chairs**

With a 100-litre tank, the AC400-1P is designed to serve 5 to 6 chairs, the ideal setup for a growing practice. This model is designed to deliver dry, oil-free, and hygienic air operating on single-phase power (three-phase also available).

**Details That Matter**

- 7-year full parts and labour warranty
- Certified food grade resin coated tank
- Added antimicrobial protection with Biocote® silver-ion lining in tank
- Noise reduction option available (see AC400Q-1P)
- Three-phase option available (See AC400)

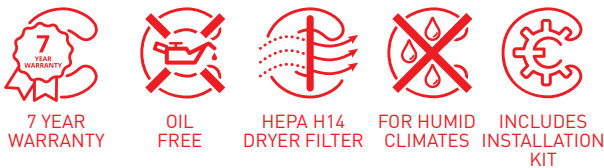

	<b>AC400-1P</b>	<b>AC400-1PE</b>
	Tandem 2 Cylinder Oil-free Dental Compressor	Tandem 2 Cylinder Oil-free Dental Compressor with Pre-filter
Item Code	013422	013422E
Price Ex GST	\$16,495.00	\$17,845.00
Price Inc GST	\$18,969.25	\$20,521.75
<b>SPECIFICATIONS</b>		
Power	2.4kW 15.4A 1PH 230V	2.4kW 15.4A 1PH 230V
Sound Output dB(A)	73	73
Max Air Flow at 5 Bar NL/min	320	320
Tank Size litres	100	100
<b>DIMENSIONS</b>		
Height mm	745	745
Width mm	1200	1200
Depth mm	550	610
Weight kg	112	112
Shipping Weight kg	134	136

**RELATED PRODUCTS**



Ventilation fan kits



Compressor parallel connection kit



Service kit

## AC400Q Quiet Tandem 2 Cylinder Oil-free Dental Compressor | 5-6 chairs

With a 100-litre tank, the AC400Q is designed to serve 5 to 6 chairs, the ideal setup for a growing practice. This model is designed with noise reduction, operating on three-phase power (single-phase also available).

### Details That Matter

- 7-year full parts and labour warranty
- Acoustic hood for significant noise reduction
- Certified food grade resin coated tank
- Added antimicrobial protection with Biocote® silver-ion lining in tank
- Single-phase option available (See AC400Q-1P)
- Unrivalled technical service back-up

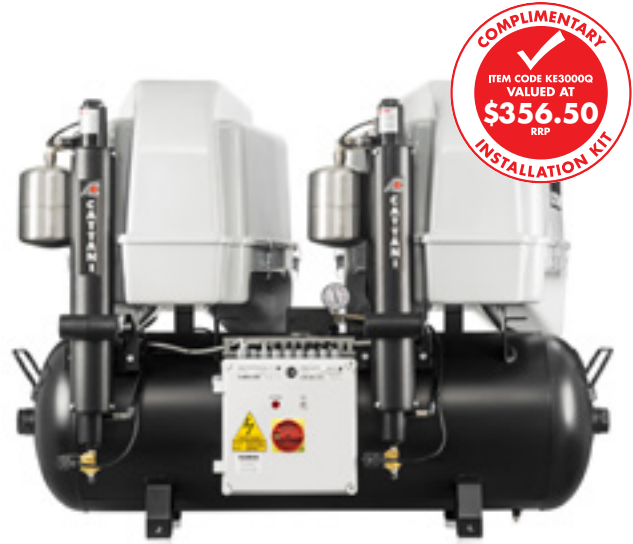

	AC400Q	AC400QE
	Quiet Tandem 2 Cylinder Oil-free Dental Compressor	Quiet Tandem 2 Cylinder Oil-free Dental Compressor with Pre-filter
Item Code	013450	013450E
Price Ex GST	\$22,295.00	\$23,645.00
Price Inc GST	\$25,639.25	\$27,191.75
<b>SPECIFICATIONS</b>		
Power	3.0kW 7.4A 3PH 400V	3.0kW 7.4A 3PH 400V
Sound Output dB(A)	63.8	63.8
Max Air Flow at 5 Bar NL/min	320	320
Tank Size litres	100	100
<b>DIMENSIONS</b>		
Height mm	890	890
Width mm	1200	1200
Depth mm	650	710
Weight kg	135	135
Shipping Weight kg	167	169

### RELATED PRODUCTS



Ventilation fan kits



Three-phase  
compressor parallel  
connection kit



Service kit

## AC400Q-1P Quiet Tandem 2 Cylinder Oil-free Dental Compressor | 5-6 chairs

With a 100-litre tank, the AC400Q-1P is designed to serve 5 to 6 chairs, the ideal setup for a growing practice. This model is designed with noise reduction, operating on single-phase power (three-phase also available).

### Details That Matter

- 7-year full parts and labour warranty
- Acoustic hood for significant noise reduction
- Certified food grade resin coated tank
- Added antimicrobial protection with Biocote® silver-ion lining in tank
- Three-phase option available (See AC400Q)



	AC400Q-1P	AC400Q-1PE
	Quiet Tandem 2 Cylinder Oil-free Dental Compressor	Quiet Tandem 2 Cylinder Oil-free Dental Compressor with Pre-filter
Item Code	013444	013444E
Price Ex GST	\$22,295.00	\$23,645.00
Price Inc GST	\$25,639.25	\$27,191.75
<b>SPECIFICATIONS</b>		
Power	2.4kW 15.4A 1PH 230V	2.4kW 15.4A 1PH 230V
Sound Output dB(A)	63.8	63.8
Max Air Flow at 5 Bar NL/min	320	320
Tank Size litres	100	100
<b>DIMENSIONS</b>		
Height mm	890	890
Width mm	1200	1200
Depth mm	650	710
Weight kg	135	135
Shipping Weight kg	167	169

### RELATED PRODUCTS



Ventilation fan kits



Compressor parallel connection kit



Service kit

## AC600 Tandem 3 Cylinder Oil-free Dental Compressor | 7-8 chairs

Designed to deliver dry, oil-free, and hygienic air at large facilities, the AC600 serves 7 to 8 chairs. With a 150-litre tank, this oil-free compressor has been rigorously tested to deliver world-class precision in dental air technology.

### Details That Matter

- 7-year full parts and labour warranty
- 150-litre tank capacity
- Certified food grade resin coated tank
- Added antimicrobial protection with Biocote® silver-ion lining in tank
- Noise reduction option available (see AC600Q)
- Unrivalled technical service back-up



	AC600	AC600E
	Tandem 3 Cylinder Oil-free Dental Compressor	Tandem 3 Cylinder Oil-free Dental Compressor with Pre-filter
Item Code	013532	013532E
Price Ex GST	\$20,695.00	\$22,045.00
Price Inc GST	\$23,799.25	\$25,351.75
<b>SPECIFICATIONS</b>		
Power	3.0kW 7.4A 3PH 400V	3.0kW 7.4A 3PH 400V
Sound Output dB(A)	74	74
Max Air Flow at 5 Bar NL/min	476	476
Tank Size litres	150	150
<b>DIMENSIONS</b>		
Height mm	890	890
Width mm	1320	1320
Depth mm	590	630
Weight kg	124	124
Shipping Weight kg	154	156

### RELATED PRODUCTS



Ventilation fan kits



Three-phase compressor parallel connection kit



Service kit

**AC600Q Quiet Tandem 3 Cylinder Oil-free Dental Compressor | 7-8 chairs**

Designed to deliver dry, oil-free, and hygienic air at large facilities, the AC600Q serves 7 to 8 chairs. This model significantly reduces noise levels, making it an excellent option when equipment is close to the surgery.

**Details That Matter**

- 7-year full parts and labour warranty
- 150-litre tank capacity
- Acoustic hood for significant noise reduction
- Certified food grade resin coated tank
- Added antimicrobial protection with Biocote® silver-ion lining in tank
- Unrivalled technical service back-up

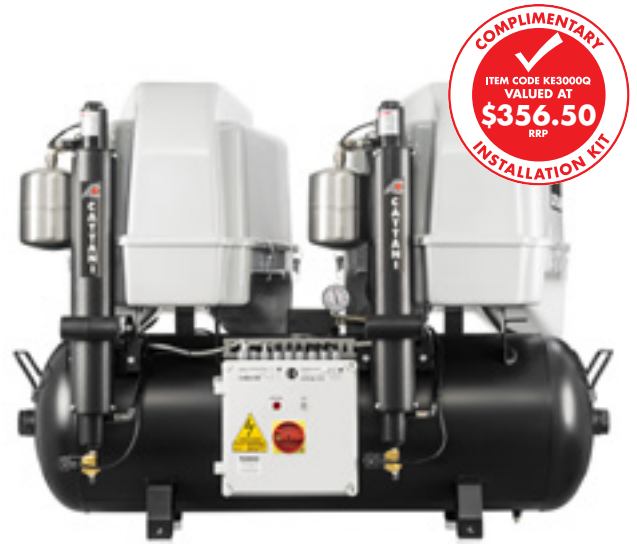











**7 YEAR WARRANTY**    **OIL FREE**    **HEPA H14 DRYER FILTER**    **FOR HUMID CLIMATES**    **LOW NOISE Q RANGE**    **INCLUDES INSTALLATION KIT**

	<b>AC600Q</b>	<b>AC600QE</b>
	Quiet Tandem 3 Cylinder Oil-free Dental Compressor	Quiet Tandem 3 Cylinder Oil-free Dental Compressor with Pre-filter
Item Code	013557	013557E
Price Ex GST	\$26,495.00	\$27,845.00
Price Inc GST	\$30,469.25	\$30,021.75
<b>SPECIFICATIONS</b>		
Power	3.0kW 7.4A 3PH 400V	3.0kW 7.4A 3PH 400V
Sound Output dB(A)	70.4	70.4
Max Air Flow at 5 Bar NL/min	476	476
Tank Size litres	150	150
<b>DIMENSIONS</b>		
Height mm	1040	1040
Width mm	1320	1320
Depth mm	770	770
Weight kg	169	169
Shipping Weight kg	205	207

**RELATED PRODUCTS**

 Ventilation fan kits  
 Three-phase compressor parallel connection kit  
 Service kit

# LARGE PLANT COMPRESSOR



## BIG IN PERFORMANCE, COMPACT IN SIZE

Specialising in delivering dental grade air to large-scale facilities including hospitals and universities, we don't just understand large installations, we are a leader in this space. As compressed air systems are imperative for critical end-uses in large facilities, we provide the best compressor systems to go with our modular installation suction systems.

All compressor systems come in dual coated tanks lined with a food grade resin and Biocote® silver ion for antimicrobial protection, backed by a 7-year warranty including full parts and labour.

### AC900 SYSTEM

- Up to 12 chairs
- Triple 3 Cylinder Oil-Free Dental Compressor
- 300-litre storage tank

### AC1200 SYSTEM

- Up to 16 chairs
- Tandem 6 Cylinder Oil-Free Dental Compressor
- 300-litre storage tank

### AC1800 SYSTEM

- Up to 24 chairs
- Triple 6 Cylinder Oil-Free Dental Compressor
- 300-litre storage tank

### AC2400 SYSTEM

- Up to 32 chairs
- Quad 6 Cylinder Oil-Free Dental Compressor
- 200-litre storage tank

**AT CATTANI, WE ARE THE FORCE  
BEHIND YOUR OPERATION.**





## AC900 Triple 3 Cylinder Oil-free Dental Compressor | Up to 12 chairs

Designed to deliver dry, oil-free, and hygienic air at large facilities, the AC900 serves up to 12 chairs. With a 300-litre tank, this oil-free compressor has been rigorously tested and ready to deliver world-class performance in dental air technology.

### Details That Matter

- 7-year full parts and labour warranty
- 300-litre tank capacity
- Certified food grade resin coated tank
- Added antimicrobial protection with Biocote® silver-ion lining in tank
- Unrivalled technical service back-up



INDENT ITEM	AC900	AC900E
	Triple 3 Cylinder Oil-free Dental Compressor	Triple 3 Cylinder Oil-free Dental Compressor with Pre-filter
Item Code	013599	013599E
Price Ex GST	\$34,985.00	\$37,010.00
Price Inc GST	\$40,232.75	\$42,561.50
SPECIFICATIONS		
Power	4.5kW 11.1A 3PH 400V	4.5kW 11.1A 3PH 400V
Sound Output dB(A)	75	75
Max Air Flow at 5 Bar NL/min	714	714
Tank Size litres	300	300
DIMENSIONS		
Height mm	1000	1000
Width mm	1800	1800
Depth mm	810	890
Weight kg	260	260
Shipping Weight kg	304	311

### RELATED PRODUCTS



Ventilation fan kits



Three-phase compressor parallel connection kit



Service kit

**AC1200 Tandem 6 Cylinder Oil-free Dental Compressor | Up to 16 chairs**

Designed to deliver dry, oil-free, and hygienic air at large facilities, the AC1200 serves up to 16 chairs. With a 300-litre tank, this high-performance unit has been rigorously tested to deliver continuous and reliable precision in air technology.

**Details That Matter**

- 7-year full parts and labour warranty
- 300-litre tank capacity
- Certified food grade resin coated tank
- Added antimicrobial protection with Biocote® silver-ion lining in tank
- Unrivalled technical service back-up



INDENT ITEM	AC1200	AC1200E
	Tandem 6 Cylinder Oil-free Dental Compressor	Tandem 6 Cylinder Oil-free Dental Compressor with Pre-filter
Item Code	013595	013595E
Price Ex GST	\$44,250.00	\$46,950.00
Price Inc GST	\$50,887.50	\$53,992.50

**SPECIFICATIONS**

Power	6.5kW 15A 3PH 400V	6.5kW 15A 3PH 400V
Sound Output dB(A)	81	81
Max Air Flow at 5 Bar NL/min	952	952
Tank Size litres	300	300

**DIMENSIONS**

Height mm	1100	1100
Width mm	1800	1800
Depth mm	880	960
Weight kg	251	254
Shipping Weight kg	302	305

**RELATED PRODUCTS**



Ventilation fan kits



Three-phase compressor parallel connection kit



Service kit

## AC1800 Triple 6 Cylinder Oil-free Dental Compressor | Up to 24 chairs

Manufactured with patented low-friction components to prolong the lifespan of the unit, the AC1800 serves up to 24 chairs. With a 300-litre tank, this high-performance unit is ready to deliver world-class precision at large facilities.

### Details That Matter

- 7-year full parts and labour warranty
- 300-litre tank capacity
- Certified food grade resin coated tank
- Added antimicrobial protection with Biocote® silver-ion lining in tank
- Unrivalled technical service back-up



INDENT ITEM	AC1800	AC1800E
	Triple 6 Cylinder Oil-free Dental Compressor	Triple 6 Cylinder Oil-free Dental Compressor with Pre-filter
Item Code	013594	013594E
Price Ex GST	\$67,125.00	\$71,175.00
Price Inc GST	\$77,193.75	\$81,851.25
<b>SPECIFICATIONS</b>		
Power	9.75kW 22.6A 3PH 400V	9.75kW 22.6A 3PH 400V
Sound Output dB(A)	82.5	82.5
Max Air Flow at 5 Bar NL/min	1428	1428
Tank Size litres	300	300
<b>DIMENSIONS</b>		
Height mm	1100	1100
Width mm	1800	1800
Depth mm	1100	1100
Weight kg	363	368
Shipping Weight kg	418	423

### RELATED PRODUCTS



Ventilation fan kits



Three-phase compressor parallel connection kit



Service kit

**AC2400 Quad 6 Cylinder Oil-free Dental Compressor | Up to 32 chairs**

The largest of our AC Cattani compressor range, the AC2400 serves up to 32 chairs. Manufactured with patented low-friction components for continuous and reliable operation, this high-performance unit is ready to deliver world-class precision at large facilities.

**Details That Matter**

- 7-year full parts and labour warranty
- 200-litre tank capacity
- Certified food grade resin coated tank
- Added antimicrobial protection with Biocote® silver-ion lining in tank
- Unrivalled technical service back-up



INDENT ITEM	AC2400
	Quad 6 Cylinder Oil-free Dental Compressor
Item Code	010656
Price Ex GST	\$133,850.00
Price Inc GST	\$153,927.50

SPECIFICATIONS	
Power	13kW 31A 3PH 400V
Sound Output dB(A)	83.5
Max Air Flow at 5 Bar NL/min	1680
Tank Size litres	200

DIMENSIONS	
Height mm	2000
Width mm	1550
Depth mm	760
Weight kg	300
Shipping Weight kg	Upon Request

**RELATED PRODUCTS**



Ventilation fan kits



Three-phase compressor parallel connection kit



Service kit

# CAD/CAM COMPRESSORS



7 YEAR  
WARRANTY



OIL  
FREE



FOR HUMID  
CLIMATES



LOW NOISE  
Q RANGE

## THE PURPOSE-BUILT ADVANTAGE

Making the correct choice for your plant equipment early on is crucial for your practice and/or dental laboratory in the long run. Cattani users know we specialise in unequalled precision and quality of purpose-built solutions. This is especially true when it comes to CAD/CAM milling.

Cattani CAD/CAM compressors are the purpose-built solution developed specifically to meet the demands set by CAD/CAM mill manufacturers.

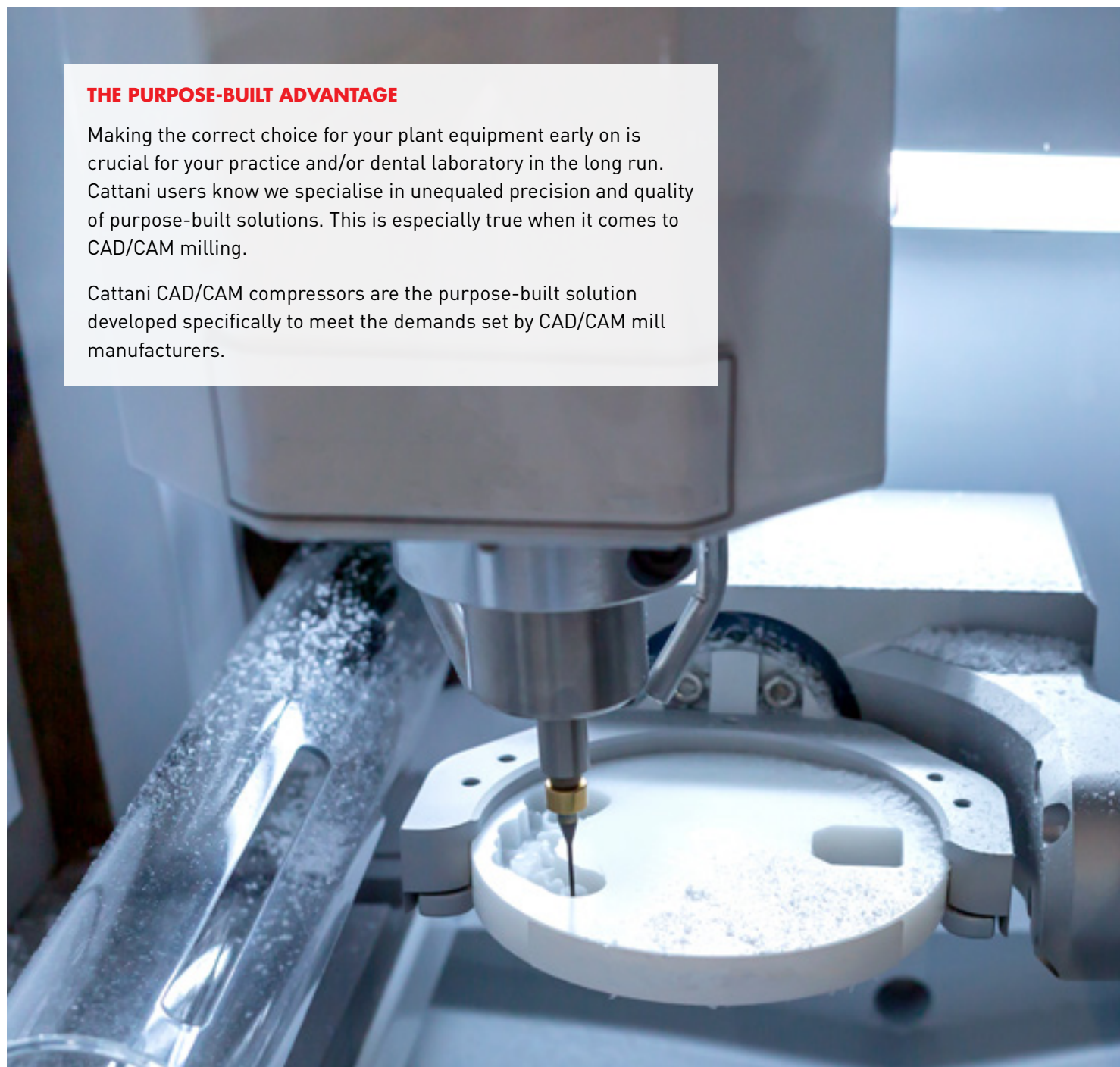

### **THE OPTIMAL PURPOSE-BUILT MILL PERFORMANCE**

Generalised solutions can be appealing in the short-term. In the case of dental grade air delivery, it is best to leave nothing to chance and have the right equipment fit for purpose. Cattani CAD/CAM compressors are built to maintain a constant and sustainable operating pressure of between 8 and 10 Bar, which is 2 Bar higher in pressure than the standard compressors.

### **IT'S NOT JUST EQUIPMENT, IT'S AN INVESTMENT**

We believe in our equipment so much that we offer a 7-year full parts and labour warranty.

### **DENTAL GRADE HYGIENE**

Cattani compressors produce quality dental grade air by removing 99.975% of particles down to 0.3 micron. Air is then preserved in a dual coated compressor tank lined with a food grade resin and Biocote® silver ion for antimicrobial protection. Cattani compressed air quality is supported by an ISO 8573-1 standard compliance with Class 1:4:2.

### **GUARANTEED CONTINUOUS AIRFLOW**

Cattani compressors guarantee a constant supply of air from the dual coated tank, even during system regeneration and cooling times. The intelligent technology is designed this way to ensure maximum performance while preserving the life of the unit.

### **NOISE REDUCTION OPTIONS AVAILABLE**

Where space is valuable and limited, noise can be an issue. For that, we offer noise reduction options for the (Q Series) CAD/CAM compressors.

#### **COMPLIMENTARY AIRLINE INSTALLATION KIT**

All compressors come with an airline installation kit – a “cost saving” package to minimise installer onsite costs, and offsite tool purchasing time.



**AT CATTANI, WE DON'T COMPROMISE. WE SPECIALISE.**

## AC310 3 Cylinder CAD/CAM Compressor

One of the most popular model in our CAD/CAM compressor range, the AC310 comes with a 45-litre tank capacity. Cattani compressors are completely oil-free, offered specifically to meet the demands set by CAD/CAM manufacturers.

### Details That Matter

- 7-year full parts and labour warranty
- Purpose-built to maintain an 8-bar pressure over long CAM cycles
- Certified food grade resin coated tank
- Added antimicrobial protection with Biocote® silver-ion lining in tank
- Noise reduction option available (see AC310Q)
- Pre-filter for humid climates available upon request



AC310	
	3 Cylinder CAD/CAM Compressor
Item Code	013310
Price Ex GST	\$12,205.00
Price Inc GST	\$14,037.75
SPECIFICATIONS	
Power	1.5kW 10.2A 1PH 230V
Sound Output dB(A)	73.6
<b>Continuous Airflow at 8 Bar NL/min</b>	<b>108</b>
Max Air Flow at 8 Bar NL/min	165
Tank Size litres	45
DIMENSIONS	
Height mm	750
Width mm	620
Depth mm	520
Weight kg	68
Shipping Weight kg	83

### RELATED PRODUCTS



Ventilation fan kits



Service kit



## AC310Q Quiet 3 Cylinder CAD/CAM Compressor

The AC310Q comes with a 45-litre tank capacity. AC310Q comes with a 45-litre tank capacity, and is ideal when noise is an issue, making them an excellent option when milling equipment is close to the surgery.

### Details That Matter

- 7-year full parts and labour warranty
- Acoustic hood for significant noise reduction
- Purpose-built to maintain an 8-bar pressure over long CAM cycles
- Certified food grade resin coated tank
- Added antimicrobial protection with Biocote® silver-ion lining in tank
- Pre-filter for humid climates available upon request



INDENT ITEM	AC310Q
-------------	--------

	Quiet 3 Cylinder CAD/CAM Compressor
Item Code	013355
Price Ex GST	\$15,105.00
Price Inc GST	\$17,370.75

SPECIFICATIONS	
----------------	--

Power	1.5kW 10.2A 1PH 230V
Sound Output dB(A)	68
<b>Continuous Airflow at 8 Bar NL/min</b>	<b>108</b>
Max Air Flow at 8 Bar NL/min	165
Tank Size litres	45

DIMENSIONS	
------------	--

Height mm	979
Width mm	720
Depth mm	700
Weight kg	84
Shipping Weight kg	104

### RELATED PRODUCTS



## AC410 Tandem 2 Cylinder CAD/CAM Compressor

Specifically built for CAD/CAM milling, the AC410 compressor comes with a 100-litre tank capacity. This model is designed to deliver dry, oil-free, and hygienic air operating on three-phase power (single-phase also available).

### Details That Matter

- 7-year full parts and labour warranty
- Purpose-built to maintain an 8-bar pressure over long CAM cycles
- Certified food grade resin coated tank
- Added antimicrobial protection with Biocote® silver-ion lining in tank
- Noise reduction option available (see AC410Q)
- Single-phase option available (see AC410-1P)
- Pre-filter for humid climates available upon request



**INDENT ITEM** **AC410**

	Tandem 2 Cylinder CAD/CAM Compressor
Item Code	013413
Price Ex GST	\$17,795.00
Price Inc GST	\$20,464.25

**SPECIFICATIONS**

Power	3kW 7.2A 3PH 400V
Sound Output dB(A)	73
<b>Continuous Airflow at 8 Bar NI/min</b>	<b>140</b>
Max Air Flow at 8 Bar NI/min	215
Tank Size litres	100

**DIMENSIONS**

Height mm	745
Width mm	1155
Depth mm	550
Weight kg	112
Shipping Weight kg	134

**RELATED PRODUCTS**



Ventilation fan kits



Service kit

## AC410-1P Tandem 2 Cylinder CAD/CAM Compressor

Specifically built for CAD/CAM milling, the AC410-1P compressor comes with a 100-litre tank capacity. This model is designed to deliver dry, oil-free, and hygienic air operating on single-phase power (three-phase also available).

### Details That Matter

- 7-year full parts and labour warranty
- Purpose-built to maintain an 8-bar pressure over long CAM cycles
- Certified food grade resin coated tank
- Added antimicrobial protection with Biocote® silver-ion lining in tank.
- Noise reduction option available (see AC410Q-1P)
- Three-phase option available (see AC410)
- Pre-filter for humid climates available upon request



INDENT ITEM	AC410-1P
	Tandem 2 Cylinder CAD/CAM Compressor
Item Code	013410
Price Ex GST	\$17,795.00
Price Inc GST	\$20,464.25
<b>SPECIFICATIONS</b>	
Power	2.4kW 15.4A 1PH 230V
Sound Output dB(A)	73
<b>Continuous Airflow at 8 Bar NI/min</b>	<b>140</b>
Max Air Flow at 8 Bar NI/min	215
Tank Size litres	100
<b>DIMENSIONS</b>	
Height mm	745
Width mm	1155
Depth mm	550
Weight kg	112
Shipping Weight kg	134

### RELATED PRODUCTS



Ventilation fan kits



Service kit

## AC410Q Quiet Tandem 2 Cylinder CAD/CAM Compressor

Specifically built for CAD/CAM milling, the AC410Q compressor comes with a 100-litre tank capacity. This model is designed for premium air delivery with noise reduction, operating on three-phase power (single-phase also available).

### Details That Matter

- 7-year full parts and labour warranty
- Purpose-built to maintain an 8-bar pressure over long CAM cycles
- Acoustic hood for significant noise reduction
- Certified food grade resin coated tank
- Added antimicrobial protection with Biocote® silver-ion lining in tank
- Single-phase option available (See AC410Q-1P)
- Pre-filter for humid climates available upon request



INDENT ITEM	AC410Q
-------------	--------

	Quiet Tandem 2 Cylinder CAD/CAM Compressor
Item Code	013458
Price Ex GST	\$23,595.00
Price Inc GST	\$27,134.25

SPECIFICATIONS	
----------------	--

Power	3kW 7.4A 3PH 400V
Sound Output dB(A)	63.8
<b>Continuous Airflow at 8 Bar NI/min</b>	<b>140</b>
Max Air Flow at 8 Bar NI/min	215
Tank Size litres	100

DIMENSIONS	
------------	--

Height mm	890
Width mm	1160
Depth mm	650
Weight kg	153
Shipping Weight kg	167

### RELATED PRODUCTS



Ventilation fan kits



Service kit

## AC410Q-1P Quiet Tandem 2 Cylinder CAD/CAM Compressor

Specifically built for CAD/CAM milling, the AC410Q-1P compressor comes with a 100-litre tank capacity. This model is designed for premium air delivery with noise reduction, operating on single-phase power (three-phase also available).

### Details That Matter

- 7-year full parts and labour warranty
- Purpose-built to maintain an 8-bar pressure over long CAM cycles
- Acoustic hood for significant noise reduction
- Certified food grade resin coated tank
- Added antimicrobial protection with Biocote® silver-ion lining in tank
- Three-phase option available (see AC410Q)
- Pre-filter for humid climates available upon request



INDENT ITEM	AC410Q-1P
-------------	-----------

	Quiet Tandem 2 Cylinder CAD/CAM Compressor
Item Code	013455
Price Ex GST	\$23,595.00
Price Inc GST	\$27,134.25

#### SPECIFICATIONS

Power	2.4kW 15.4A 1PH 230V
Sound Output dB(A)	63.8
<b>Continuous Airflow at 8 Bar NI/min</b>	<b>140</b>
Max Air Flow at 8 Bar NI/min	215
Tank Size litres	100

#### DIMENSIONS

Height mm	890
Width mm	1160
Depth mm	650
Weight kg	153
Shipping Weight kg	167

#### RELATED PRODUCTS



Ventilation fan kits



Service kit

## AC610 Tandem 3 Cylinder CAD/CAM Compressor

The AC610 compressor is designed to deliver premium quality for higher performance requirements. With a 150-litre tank capacity, this oil-free compressor has been rigorously tested to deliver world-class precision for CAD/CAM milling.

### Details That Matter

- 7-year full parts and labour warranty
- Purpose-built to maintain an 8-bar pressure over long CAM cycles
- 150-litre tank capacity
- Certified food grade resin coated tank
- Added antimicrobial protection with Biocote® silver-ion lining in tank
- Noise reduction option available (see AC610Q)
- Pre-filter for humid climates available upon request



INDENT ITEM	AC610
-------------	-------

	Tandem 3 Cylinder CAD/CAM Compressor
Item Code	013513
Price Ex GST	\$21,995.00
Price Inc GST	\$25,294.25

SPECIFICATIONS	
----------------	--

Power	3kW 7.4A 3PH 400V
Sound Output dB(A)	74
<b>Continuous Airflow at 8 Bar NI/min</b>	<b>217</b>
Max Air Flow at 8 Bar NI/min	330
Tank Size litres	150

DIMENSIONS	
------------	--

Height mm	890
Width mm	1320
Depth mm	590
Weight kg	124
Shipping Weight kg	154

### RELATED PRODUCTS



Ventilation fan kits



Service kit

## AC610Q Quiet Tandem 3 Cylinder CAD/CAM Compressor

The AC610Q compressor comes with a 150-litre tank capacity for higher performance requirements. Our Q series of compressors significantly reduces noise levels, making them an excellent option when CAD/CAM equipment is close to the surgery.

### Details That Matter

- 7-year full parts and labour warranty
- Purpose-built to maintain an 8-bar pressure over long CAM cycles
- Acoustic hood for significant noise reduction
- 150-litre tank capacity
- Certified food grade resin coated tank
- Added antimicrobial protection with Biocote® silver-ion lining in tank
- Pre-filter for humid climates available upon request



**INDENT ITEM** **AC610Q**

Quiet Tandem 3 Cylinder CAD/CAM Compressor

Item Code	013558
Price Ex GST	\$27,795.00
Price Inc GST	\$31,964.25

**SPECIFICATIONS**

Power	3kW 7.4A 3PH 400V
Sound Output dB(A)	70.4
<b>Continuous Airflow at 8 Bar NI/min</b>	<b>217</b>
Max Air Flow at 8 Bar NI/min	330
Tank Size litres	150

**DIMENSIONS**

Height mm	1040
Width mm	1320
Depth mm	770
Weight kg	174
Shipping Weight kg	205

**RELATED PRODUCTS**



Ventilation fan kits



Service kit

## AC910 Triple 3 Cylinder CAD/CAM Compressor

Our largest of the CAD/CAM compressor range, the AC910 comes with a 300-litre tank capacity. All our compressors are oil-free and have been rigorously tested to deliver world class performance in dental air technology.

### Details That Matter

- 7-year full parts and labour warranty
- Purpose-built to maintain an 8-bar pressure over long CAM cycles
- 300-litre tank capacity
- Certified food grade resin coated tank
- Added antimicrobial protection with Biocote® silver-ion lining in tank.
- Pre-filter for humid climates available upon request



**INDENT ITEM** **AC910**

	Triple 3 Cylinder CAD/CAM Compressor
Item Code	013578
Price Ex GST	\$36,285.00
Price Inc GST	\$41,727.75

**SPECIFICATIONS**

Power	4.5kW 11.1A 3PH 400V
Sound Output dB(A)	75
<b>Continuous Airflow at 8 Bar NI/min</b>	<b>326</b>
Max Air Flow at 8 Bar NI/min	495
Tank Size litres	300

**DIMENSIONS**

Height mm	1000
Width mm	1800
Depth mm	810
Weight kg	258
Shipping Weight kg	304

**RELATED PRODUCTS**



Ventilation fan kits



Service kit



# COMPRESSOR ACCESSORIES

## Acoustic Cabinet for AC100, AC200 and AC300

The Cattani acoustic cabinet is a complete weatherproof, temperature controlled and acoustic solution. Designed for both outdoors or indoors installation. The cabinet is made using electro-galvanised metal plate and epoxy-polyester powders that can withstand rain and direct sunlight in hot and cold climates. The cabinet includes an inbuilt fan to effectively ventilate the compressor.

Reduces noise of the compressor to:

AC100 - 50 dB(A)

AC200 - 51 dB(A)

AC300 - 51 dB(A)



Order Number	Description	Price Inc GST
K-010800	Acoustic Cabinet 870mm W x 887mm H x 700mm D (84kg)	\$5,893.18

## Single Phase Compressor Parallel Connection Kit

Designed to allow like for like compressors to run in parallel allowing for greater dental chair capacity.

D-RK2000 - Suitable to run 2 x AC100, 2 x AC200 or 2 x AC300

D-RK3000 - Suitable to run 2 x AC300Q



Order Number	Price Inc GST
D-RK2000	\$2,736.43
D-RK3000	\$2,736.43

## Three Phase Compressor Parallel Connection Kit

Designed to allow up to 4 of the same three phase type of compressors to run in parallel allowing for greater dental chair capacity.

Order Number	Description	Price Inc GST
K-070904	Suitable for 3PH compressor models	\$4,578.15



**\*Please contact your Business Development Manager for recommendations on the appropriate air regulator for multiple compressor installations.**

## COMPRESSOR ACCESSORIES

### HEPA H14 Filter for Compressor Drying Column

HEPA H14 filter and o-ring pack for drying column.

Order Number	Pack Qty	Price Inc GST
K168429-1	1	\$155.25

STOCKED ITEM



### Air Inlet Filter for Compressor Head Unit

Order Number	Pack Qty	Price Inc GST
K-168563	1	\$97.75

STOCKED ITEM



### Dryer Pre Filter (for Humid Climates) Kit for Compressor

Fitted between the condenser and the desiccant dryer, and removes a percentage of condensation from the air before reaching the dryer. Can be easily retrofitted to existing compressors. (1 filter required per desiccant dryer, therefore 2 filters required for AC400 and AC600 etc).

Order Number	Pack Qty	Price Inc GST
K-E10000	1	\$820.53



### Ventilation Fan Kits

Recommendations – 150 m<sup>3</sup>/hr for each kW of equipment installed.

Order Number	Description	Price Inc GST
L-TD2500-KIT	250m <sup>3</sup> /hr kit includes fan, ducting and vent cover	\$1,141.38
L-TD5000-150	500m <sup>3</sup> /hr kit includes fan, ducting and vent cover	\$1,717.53
L-TD8000	800m <sup>3</sup> /hr kit includes fan only	\$1,960.18



## COMPRESSOR SERVICE KITS

### Minor Service Kits (HEPA H14 Filter for Drying Column)

Includes inlet filters for head unit, HEPA H14 filter for the drying column and a replacement o-ring.

Order Number	Description	Pack Qty	Price Inc GST
K-SK1013B	1 Cylinder Head Unit with HEPA H14 Filter – Minor Service Kit	1	\$278.88
K-SK2013B	2 Cylinder Head Unit with HEPA H14 Filter – Minor Service Kit	1	\$377.20
K-SK3013B	3 Cylinder Head Unit with HEPA H14 Filter – Minor Service Kit	1	\$473.23
K-SK010611B	6 Cylinder Head Unit with HEPA H14 Filter – Minor Service Kit	1	\$756.70



### Intermediate Service Kits (HEPA H14 Filter for Drying Column) Single Phase Systems Only

Includes inlet filters for head unit, HEPA H14 filter for the drying column, a replacement o-ring and suitable motor start capacitor.

Order Number	Description	Pack Qty	Price Inc GST
K-SK101B	1 Cylinder Head Unit with HEPA H14 Filter - Intermediate Service Kit	1	\$426.65
K-SK201B	2 Cylinder Head Unit with HEPA H14 Filter - Intermediate Service Kit	1	\$647.45
K-SK301B	3 Cylinder Head Unit with HEPA H14 Filter - Intermediate Service Kit	1	\$685.40



### Compressor Airline Installation Kit

Order Number	Description	Pack Qty	Price Inc GST
K-E20000	Compressor Airline Connection Kit with Reg and Gauge (AC100-AC300)	1	\$210.00
K-E30000	Compressor Airline Connection Kit with Reg and Gauge (AC400-AC600)	1	\$356.50
K-E3000Q	Compressor Airline Connection Kit with Reg and Gauge (AC400Q-AC600Q)	1	\$356.50
K-E90000	Compressor Airline Connection Kit with Reg and Gauge (AC900)	1	\$356.50

Note: These kits are included with compressor purchase.

### Capacitors

Order Number	Description	Pack Qty	Price Inc GST
C-189146	20 µF Capacitor C87.0 "UL" Metal With 150mm Cable AC100 and AC100Q	1	\$143.18
C-189147	40 µF Capacitor C87.0 "UL" Metal With 350mm Cable AC200 and AC200Q	1	\$228.28
C-189148	55 µF Capacitor C87.0 "UL" Metal With 150mm Cable AC300 and AC300Q	1	\$285.20

STOCKED ITEM  
(C-189148)

# SMART SUCTION



## OPTIMISE AND SAVE

Rather than being a follower of the past, we choose to be a pioneer of the future. At Cattani, we decided to be one of the first in the dental industry to use variable frequency inverter technology.

Traditional suction motors have a fixed speed that makes them notoriously inefficient. For example, when only a small number of chairs are in use, the motor's energy consumption remains constantly high. But Cattani SMART suction motors can adjust performance accordingly, as it always know what's going on in the surgeries, thanks to inverter technology.

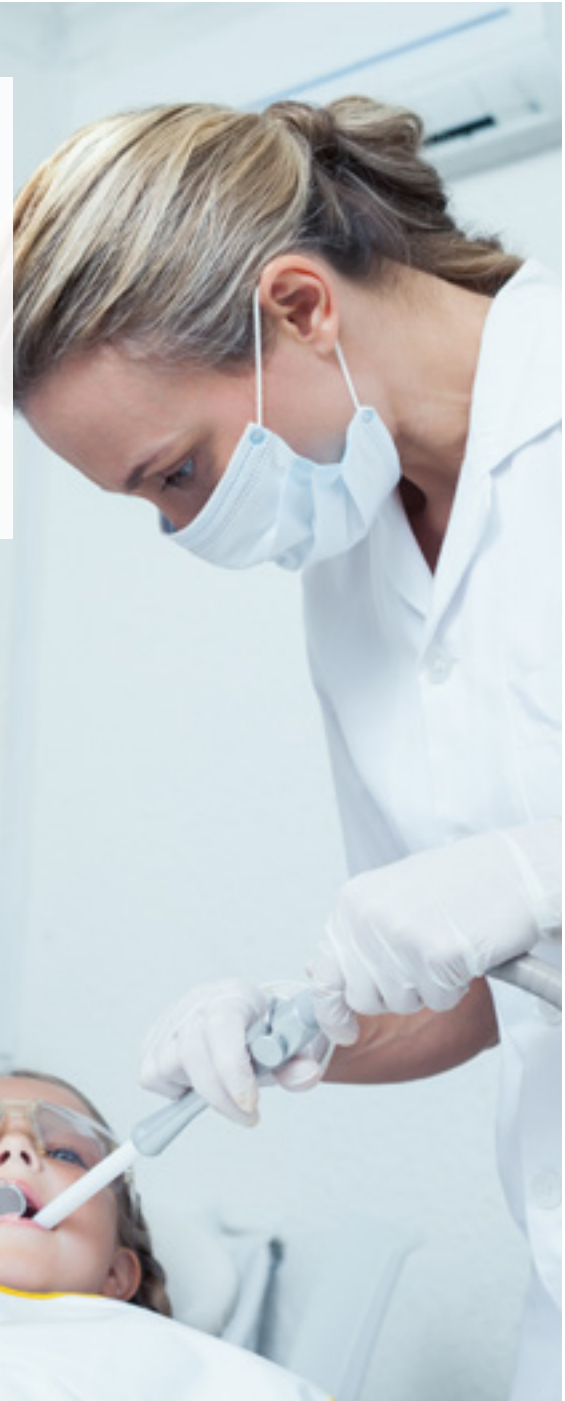

### SMART AND ECONOMICAL

Pioneered by Cattani, the inverter control intelligence is designed to optimise performance suction, while reducing energy costs. From the number of chairs in use, down to size of suction tip, the inverter control senses the real-time requirements of your practice, to adjust the unit speed and output accordingly. No more, no less.

### SMART SELF-PROTECTION MODE

In the event of a functional anomaly that could damage the machine, such as overload of fluids, excessive temperatures or even power surge, the SMART suction unit automatically switches to self-protection mode to overcome the issue, returning to normal operation once the situation is stabilised.

### NOISE REDUCTION BY HALF

The SMART Cube suction range is a perfect example of what can be achieved by Cattani innovation. The Cube's acoustic housing has the ability to cut perceived noise by half, not to mention the lower running costs through its clever design and inverter technology.

### PLUG AND PLAY POSSIBILITIES

As a market leader in modular installations, our "plug and play" parallel installation allows SMART suction systems to communicate with each other to deliver precise performance for your practice. From the single chair up to a hospital and university set-up, we have configurations to suit all needs, while ensuring built-in redundancy to ensure continuous operation.

### AMALGAM RETENTION

As a world leader in amalgam separation, Cattani's Hydrocyclone technology is at the forefront of amalgam retention technology. The Hydrocyclone has a retention rate of more than 98%, with no extra power consumption or noise, and can be easily retrofitted by a technician.

### IT'S NOT JUST EQUIPMENT, IT'S AN INVESTMENT

We believe in our equipment so much that we offer an 3-year warranty (including full parts and labour) on all our SMART suction units.

### INSTALLATION EASE

All SMART suction systems come with an installation kit – a "cost saving" package to minimise installer onsite and offsite expenses.



Turbo SMART Cube

Turbo SMART

**AT CATTANI, WE DON'T COMPROMISE. WE OPTIMISE.**

# SMART CUBE: HALF AS LOUD



## PEACE AND QUIET, PEACE OF MIND

All plant room equipment generates fluctuating noise which is inevitable at any dental practice. This led Cattani engineers to develop an innovative solution that not only reduces noise, but also with lower operating costs. Cattani's SMART Cube suction range is the prime example of what can be achieved with noise reduction and other efficiencies.

## THE SCIENCE WITHIN THE HOUSING

Cattani's engineers have been able to cut perceived noise by 50% with the Cube's acoustic housing. The Cube's compact design is just as powerful as its SMART counterparts, but uses a smaller motor, translating into lower running costs. With inverter technology as part of the package, energy savings are a given with SMART Cube.

## ENVIRONMENTAL SUSTAINABILITY

The introduction of our SMART suction systems in 2015 has shown a significant reduction in raw materials used compared to our Classic suction range. The vast improvement from this evolution has been evident in our Turbo SMART Cube system, where 13 kg (59%) of raw materials have been spared in each unit.

- Acoustic housing cuts perceived noise by 50%
- Inverter control slashes energy consumption
- Active self-protection mode during emergencies
- Sustainable production
- 3-year warranty with full parts and labour

## SMART SELF-PROTECTION MODE

In the event of a functional anomaly that could damage the machine, such as overload of fluids, excessive temperatures or even power surge, the SMART suction unit automatically switches to self-protection mode to overcome the issue, returning to normal operation once the situation is stabilised.

**SMART CUBE PROMISES NOT ONLY PEACE AND QUIET, BUT ALSO PEACE OF MIND.**

# INVERTER TECHNOLOGY

## THE TRUE MEANING OF PEAK PRECISION PERFORMANCE

Traditionally, conventional motor systems can lose over half their input energy before delivering end-use service. Therefore, whilst performance of the individual motor may be high, the efficiency of the whole system could improve substantially. This is where Cattani's inverter technology helps overcome this energy efficiency problem.

Cattani pioneered the use of inverter technology in dental suction equipment, which use a variable frequency drive (VFD) or variable speed drive (VSD) to control the speed of the motor for the purpose of energy saving and precision in performance control.

## BENEFITS OF INVERTER CONTROL:

- Power saving efficiency
- Independent variable speed control and speed transition control of the centrifugal separator and suction motor
- System management from multiple inputs (voltage monitoring, current monitoring, temperature monitoring for machine self-protection and fluid flow management).

## ULTIMATE CONTROL

The inverter technology controls the rotational speed of the motor by controlling its frequency and voltage supply. As the performance demand changes, the inverter control can simply increase or decrease the motor speed to meet the suction requirement. Each motor, (centrifuge and suction) are intelligently controlled by an independent inverter module. The result is constant, consistent, and reliable suction for a great patient and user experience.

## WHY SMART MATTERS

SMART suction inverter technology uses sensors to measure this demand for suction and adjusts the motor's speed to deliver precision performance. From the number of chairs in use, right down to size of suction tip and volume of fluids being aspirated, the inverter control identifies real-time requirements of your practice, monitoring its performance, as well as detecting and reporting abnormalities.

## PLUG AND PLAY, FOR CONTINUOUS OPERATION

Thanks to inverter technology, Cattani leads the way in modular installation of parallel units. Our "plug and play" parallel installation allows SMART suction systems to communicate with each other to deliver peak precision performance for your facility. From the single chair up to a hospital and university set-up, we have configurations to suit all needs, while ensuring built-in redundancy to ensure continuous operation.

**AT CATTANI, WE HAVE MASTERED PRECISION.**



# AMALGAM RETENTION: THE CATTANI HYDROCYCLONE

Cattani is passionate about protecting the environment for future generations and has been at the forefront of addressing amalgam retention and separation.

The Hydrocyclone is a clever and effective concept that uses the fluid pressure created by the suction system to separate and retain amalgam, all without the need for moving parts. Fluids enter the Hydrocyclone cone and are forced downward in a spiral motion.

When the fluids hit the base of the Hydrocyclone they are forced to make a rapid inversion, while the heavier amalgam particles fall into a collection canister. If fluid velocity is not sufficient to achieve maximum retention, the system is intelligent enough to force the fluids back into the machine to recirculate until retention is achieved.

The retention rate of 98% or more exceeds with ISO 11143.

## **NO ADDITIONAL POWER CONSUMPTION, NO NOISE, NO EXTRA SPACE**

The beauty of the Hydrocyclone unit is that it uses no additional power at all, creates no noise, and operates within the same footprint of the SMART suction system. This is a revolutionary step towards a more sustainable world.

## **EASY INSTALLATION WITH RETROFIT OPTION**

Cattani SMART suction units can easily be retrofitted with Hydrocyclone units at any stage. As the Hydrocyclone fits within the same footprint of the existing SMART suction system no additional space requirements are needed.

The process is carried out on-site by a trained technician and takes less than an hour, to ensure minimal disruption to operation.

## **COLLECTION AND REPLACEMENT**

Efficient collection and replacement of canisters is also very simple. Cattani has partnered with specialist recycling company ECOCYCLE.

Contact ECOCYCLE directly to arrange your canister collection and recycling:



**AU: 1300 32 62 92**  
**NZ: 0800 732 922**

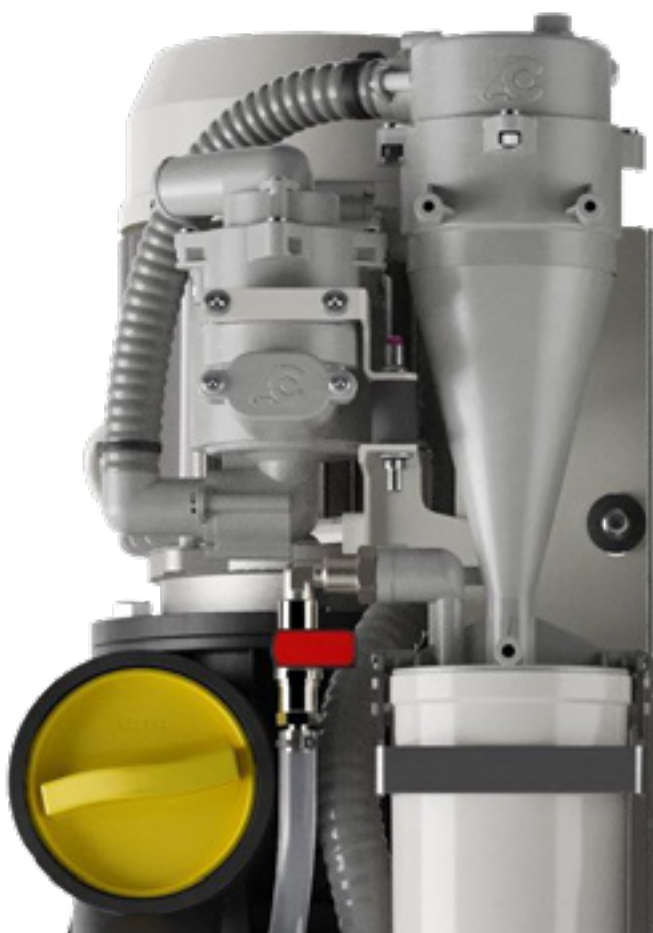

- Exceeds ISO 11143 Amalgam retention standard
- Fits within footprint of suction system
- No additional power required
- No additional noise

**AT CATTANI, WE ARE ABOUT SUSTAINABILITY.**



**Micro SMART with Keypad | 1-2 chairs**

The most compact of our high-performance SMART suction range, the Micro SMART with Keypad is designed to serve 1 to 2 chairs. Developed with inverter control to provide consistent, high-performance suction while reducing energy costs.

**Details That Matter**

- 3-year full parts and labour warranty
- Inverter control for performance and energy efficiency
- SMART self-protection in case of functional anomalies
- Modular installation capabilities
- Noise reduction option available (see SMART Cube)
- Amalgam retention option available



<b>Micro SMART with Keypad</b>	
Item Code	035050TP
Price Ex GST	\$8,005.00
Price Inc GST	\$9,205.75
<b>SPECIFICATIONS</b>	
Power	1.12kW 8A 1PH 230V
Sound Output dB(A)	64
Max Air Flow at l/min	900
Max Vacuum for Continuous Operation mBar	210
<b>DIMENSIONS</b>	
Height mm	600
Width mm	380
Depth mm	350
Weight kg	31
Shipping Weight kg	32

**RELATED PRODUCTS**



**PULI-JET Gentle 2.0**  
Non-foaming  
Disinfectant



**Pulse Cleaner**



**Antifoaming Disinfectant Tablets**

**Micro SMART with ISO 6 Hydrocyclone | 1-2 chairs**

The most compact of our high-performance SMART suction range, the Micro SMART is designed to serve 1 to 2 chairs. Integrated with ISO 6 Hydrocyclone amalgam retention.

**Details That Matter**

- 3-year full parts and labour warranty
- ISO 6 Hydrocyclone amalgam retention
- Inverter control for performance and energy efficiency
- SMART self-protection in case of functional anomalies
- Modular installation capabilities
- Noise reduction option available (see SMART Cube)



**Micro SMART with ISO 6 Hydrocyclone**

Item Code	035060
Price Ex GST	\$8,590.00
Price Inc GST	\$9,878.50

**SPECIFICATIONS**

Power	1.12kW 8A 1PH 230V
Sound Output dB(A)	64
Max Air Flow at l/min	900
Max Vacuum for Continuous Operation mBar	210

**DIMENSIONS**

Height mm	600
Width mm	380
Depth mm	350
Weight kg	33
Shipping Weight kg	34

STOCKED ITEM

**RELATED PRODUCTS**



**PULI-JET Gentle 2.0  
Non-foaming  
Disinfectant**



**Pulse Cleaner**



**Antifoaming  
Disinfectant Tablets**

**Micro SMART Cube | 1-2 chairs**

The most compact of our high-performance SMART suction Cube range, the Micro SMART Cube is designed to serve 1 to 2 chairs. The Cube's acoustic housing cuts perceived noise by 50%.

**Details That Matter**

- 3-year full parts and labour warranty
- Acoustic housing reducing perceived noise by 50%
- Inverter control for performance and energy efficiency
- SMART self-protection in case of functional anomalies
- Modular installation capabilities
- Amalgam retention option available



Micro SMART Cube	
Item Code	035031TP
Price Ex GST	\$8,280.00
Price Inc GST	\$9,522.00
<b>SPECIFICATIONS</b>	
Power	0.95KW 5.8A 1PH 230V
Sound Output dB(A)	59
Max Air Flow at l/min	1000
Max Vacuum for Continuous Operation mBar	210
<b>DIMENSIONS</b>	
Height mm	470
Width mm	420
Depth mm	350
Weight kg	31
Shipping Weight kg	33

**RELATED PRODUCTS**



**PULI-JET Gentle 2.0**  
Non-foaming  
Disinfectant



**Pulse Cleaner**



**Antifoaming Disinfectant Tablets**

**Micro SMART Cube with ISO 6 Hydrocyclone | 1-2 chairs**

The most compact of our high-performance SMART suction Cube range, the Micro SMART is designed to serve 1 to 2 chairs. Integrated with amalgam retention, the Cube's acoustic housing cuts perceived noise by 50%.

**Details That Matter**

- 3-year full parts and labour warranty
- Acoustic housing reducing perceived noise by 50%
- ISO 6 Hydrocyclone amalgam retention
- Inverter control for performance and energy efficiency
- SMART self-protection in case of functional anomalies
- Modular installation capabilities



**Micro SMART Cube with ISO 6 Hydrocyclone**

Item Code	035030
Price Ex GST	\$9,405.00
Price Inc GST	\$10,815.75

**SPECIFICATIONS**

Power	0.95KW 5.8A 1PH 230V
Sound Output dB(A)	59
Max Air Flow at l/min	1000
Max Vacuum for Continuous Operation mBar	210

**DIMENSIONS**

Height mm	470
Width mm	420
Depth mm	350
Weight kg	31
Shipping Weight kg	34

STOCKED ITEM

**RELATED PRODUCTS**



PULI-JET Gentle 2.0  
Non-foaming  
Disinfectant



Pulse Cleaner

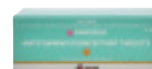

Antifoaming  
Disinfectant Tablets

## Turbo SMART A | 2-3 chairs

Designed with Cattani pioneered inverter technology, the Turbo SMART A delivers consistent, high-performance suction to 2 to 3 chairs. Capable of upgrading to Turbo SMART B to serve 4 chairs, without the need for additional space.

### Details That Matter

- 3-year full parts and labour warranty
- Capability to upgrade to a 4-chair capacity
- Inverter control for performance and energy efficiency
- SMART self-protection in case of functional anomalies
- Modular installation capabilities
- Amalgam retention option available
- Noise reduction option available (see SMART Cube)



Turbo SMART A	
Item Code	035105
Price Ex GST	\$10,915.00
Price Inc GST	\$12,552.25
<b>SPECIFICATIONS</b>	
Power	1.5kW 6.5A 1PH 230V
Sound Output dB(A)	69
Max Air Flow at l/min	1400
Max Vacuum for Continuous Operation mBar	210
<b>DIMENSIONS</b>	
Height mm	645
Width mm	400
Depth mm	330
Weight kg	49
Shipping Weight kg	52

STOCKED ITEM

### RELATED PRODUCTS



**PULI-JET Gentle 2.0**  
Non-foaming  
Disinfectant



**Pulse Cleaner**



**Antifoaming Disinfectant Tablets**

**Turbo SMART A with ISO 18 Hydrocyclone | 2-3 chairs**

Designed with inverter technology, the Turbo SMART A delivers consistent, high-performance suction to 2 to 3 chairs. Integrated with amalgam retention, with the capability of upgrading to Turbo SMART B to serve 4 chairs.

**Details That Matter**

- 3-year full parts and labour warranty
- Capability to upgrade to a 4-chair capacity
- ISO 18 Hydrocyclone amalgam retention
- Inverter control for performance and energy efficiency
- SMART self-protection in case of functional anomalies
- Modular installation capabilities.
- Noise reduction option available (see SMART Cube)







**3 YEAR WARRANTY**



**INVERTER CONTROL**



**AMALGAM RETENTION**



**INCLUDES INSTALLATION KIT**

**Turbo SMART A with ISO 18 Hydrocyclone**

Item Code	035115
Price Ex GST	\$11,500.00
Price Inc GST	\$13,225.00

**SPECIFICATIONS**

Power	1.5kW 6.5A 1PH 230V
Sound Output dB(A)	69
Max Air Flow at l/min	1400
Max Vacuum for Continuous Operation mBar	210

**DIMENSIONS**

Height mm	645
Width mm	400
Depth mm	330
Weight kg	50
Shipping Weight kg	54

STOCKED ITEM

**RELATED PRODUCTS**



**PULI-JET Gentle 2.0**  
Non-foaming  
Disinfectant



**Pulse Cleaner**



**Antifoaming Disinfectant Tablets**

**Turbo SMART A Cube | 2-3 chairs**

Designed with inverter technology, the Turbo SMART A delivers consistent, high-performance suction to 2 to 3 chairs. Comes with noise reduction acoustic housing, with the capability of upgrading to Turbo SMART B to serve 4 chairs.

**Details That Matter**

- 3-year full parts and labour warranty
- Acoustic housing reducing perceived noise by 50%
- Capability to upgrade to a 4-chair capacity
- Inverter control for performance and energy efficiency
- SMART self-protection in case of functional anomalies
- Modular installation capabilities
- Amalgam retention option available



<b>Turbo SMART A Cube</b>	
Item Code	035121
Price Ex GST	\$11,890.00
Price Inc GST	\$13,673.50
<b>SPECIFICATIONS</b>	
Power	1.1kW 6.8A 1PH 230V
Sound Output dB(A)	60
Max Air Flow at l/min	1400
Max Vacuum for Continuous Operation mBar	210
<b>DIMENSIONS</b>	
Height mm	650
Width mm	500
Depth mm	370
Weight kg	43
Shipping Weight kg	53

STOCKED ITEM

**RELATED PRODUCTS**



**PULI-JET Gentle 2.0**  
Non-foaming  
Disinfectant



**Pulse Cleaner**



**Antifoaming Disinfectant Tablets**

## Turbo SMART A Cube with ISO 18 Hydrocyclone | 2-3 chairs

Designed with inverter technology, the Turbo SMART A delivers consistent, high-performance suction to 2 to 3 chairs. Integrated with Hydrocyclone amalgam retention, with the capability of upgrading to Turbo SMART B to serve 4 chairs.

### Details That Matter

- 3-year full parts and labour warranty
- Acoustic housing reducing perceived noise by 50%
- ISO 18 Hydrocyclone amalgam retention
- Capability to upgrade to a 4-chair capacity
- Inverter control for performance and energy efficiency
- SMART self-protection in case of functional anomalies



### Turbo SMART A Cube with ISO 18 Hydrocyclone

Item Code	035120
Price Ex GST	\$12,475.00
Price Inc GST	\$14,346.25

#### SPECIFICATIONS

Power	1.1kW 6.8A 1PH 230V
Sound Output dB(A)	60
Max Air Flow at l/min	1400
Max Vacuum for Continuous Operation mBar	210

#### DIMENSIONS

Height mm	650
Width mm	500
Depth mm	370
Weight kg	44
Shipping Weight kg	55

STOCKED ITEM

### RELATED PRODUCTS



**PULI-JET Gentle 2.0**  
Non-foaming  
Disinfectant



**Pulse Cleaner**



**Antifoaming  
Disinfectant Tablets**



## Turbo SMART B | Up to 4 chairs

Designed with Cattani pioneered inverter technology, the Turbo SMART B adjusts performance according to suction demands, improving energy efficiency. This model delivers consistent, high-performance suction to 4 chairs.

### Details That Matter

- 3-year full parts and labour warranty
- Inverter technology for performance control and energy efficiency
- SMART self-protection in case of functional anomalies
- Modular installation capabilities
- Amalgam retention option available
- Noise reduction option available (see SMART Cube)



Turbo SMART B	
Item Code	035105B
Price Ex GST	\$12,300.00
Price Inc GST	\$14,145.00
<b>SPECIFICATIONS</b>	
Power	1.8kW 7.5A 1PH 230V
Sound Output dB(A)	73.7
Max Air Flow at l/min	1750
Max Vacuum for Continuous Operation mBar	210
<b>DIMENSIONS</b>	
Height mm	645
Width mm	400
Depth mm	330
Weight kg	50
Shipping Weight kg	52

STOCKED ITEM

### RELATED PRODUCTS



**PULI-JET Gentle 2.0**  
Non-foaming  
Disinfectant



**Pulse Cleaner**



**Antifoaming Disinfectant Tablets**

**Turbo SMART B with ISO 18 Hydrocyclone | Up to 4 chairs**

Designed with Cattani pioneered inverter technology, the Turbo SMART B delivers consistent, high-performance suction to 4 chairs. Integrated with ISO 18 Hydrocyclone amalgam retention.

**Details That Matter**

- 3-year full parts and labour warranty
- Inverter control for performance and energy efficiency
- ISO 18 Hydrocyclone amalgam retention
- SMART self-protection in case of functional anomalies
- Modular installation capabilities
- Noise reduction option available (see SMART Cube)







**3 YEAR WARRANTY**



**INVERTER CONTROL**



**AMALGAM RETENTION**



**INCLUDES INSTALLATION KIT**

**Turbo SMART B with ISO 18 Hydrocyclone**

Item Code	035115B
Price Ex GST	\$12,885.00
Price Inc GST	\$14,817.75

**SPECIFICATIONS**

Power	1.8kW 7.5A 1PH 230V
Sound Output dB(A)	73.7
Max Air Flow at l/min	1750
Max Vacuum for Continuous Operation mBar	210

**DIMENSIONS**

Height mm	645
Width mm	400
Depth mm	330
Weight kg	50
Shipping Weight kg	54

STOCKED ITEM

**RELATED PRODUCTS**



**PULI-JET Gentle 2.0 Non-foaming Disinfectant**



**Pulse Cleaner**



**Antifoaming Disinfectant Tablets**

## Turbo SMART B Cube | Up to 4 chairs

Designed with Cattani-pioneered inverter technology, the Turbo SMART B adjusts performance according to suction demands, improving energy efficiency. Comes with noise reduction acoustic housing, delivering high-performance suction to 4 chairs.

### Details That Matter

- 3-year full parts and labour warranty
- Acoustic housing reducing perceived noise by 50%
- Inverter technology for performance control and energy efficiency
- SMART self-protection in case of functional anomalies
- Modular installation capabilities
- Amalgam retention option available



Turbo SMART B Cube	
Item Code	035121B
Price Ex GST	\$13,275.00
Price Inc GST	\$15,266.25
<b>SPECIFICATIONS</b>	
Power	1.5kW 8.7A 1PH 230V
Sound Output dB(A)	60
Max Air Flow at l/min	1700
Max Vacuum for Continuous Operation mBar	210
<b>DIMENSIONS</b>	
Height mm	650
Width mm	500
Depth mm	370
Weight kg	44
Shipping Weight kg	53

### RELATED PRODUCTS



PULI-JET Gentle 2.0  
Non-foaming  
Disinfectant



Pulse Cleaner



Antifoaming  
Disinfectant Tablets



**Turbo SMART B Cube with ISO 18 Hydrocyclone | Up to 4 chairs**

Designed with Cattani-pioneered inverter technology, the Turbo SMART B delivers consistent, high-performance suction to 4 chairs. Comes with noise reduction acoustic housing and integrated with ISO 18 Hydrocyclone amalgam retention.

**Details That Matter**

- 3-year full parts and labour warranty
- ISO 18 Hydrocyclone amalgam retention
- Acoustic housing reducing perceived noise by 50%
- Inverter control for performance and energy efficiency
- SMART self-protection in case of functional anomalies
- Modular installation capabilities



				
3 YEAR WARRANTY	INVERTER CONTROL	AMALGAM RETENTION	LOW NOISE	INCLUDES INSTALLATION KIT

**Turbo SMART B Cube with ISO 18 Hydrocyclone**

Item Code	035120B
Price Ex GST	\$13,860.00
Price Inc GST	\$15,939.00

**SPECIFICATIONS**

Power	1.5kW 8.7A 1PH 230V
Sound Output dB(A)	60
Max Air Flow at l/min	1700
Max Vacuum for Continuous Operation mBar	210

**DIMENSIONS**

Height mm	650
Width mm	500
Depth mm	370
Weight kg	44
Shipping Weight kg	55

**RELATED PRODUCTS**



PULI-JET Gentle 2.0  
Non-foaming  
Disinfectant



Pulse Cleaner



Antifoaming  
Disinfectant Tablets

## Turbo SMART B 2V | Up to 4 chairs

Designed with Cattani-pioneered inverter technology, the Turbo SMART B delivers consistent, high-performance suction to 4 chairs. Comes with noise reduction acoustic housing and integrated with ISO 18 Hydrocyclone amalgam retention.

### Details That Matter

- 3-year full parts and labour warranty
- Inverter control for performance and energy efficiency
- SMART self-protection in case of functional anomalies
- Modular installation capabilities



Turbo SMART B 2V	
Item Code	035130
Price Ex GST	\$14,155.00
Price Inc GST	\$16,278.25
<b>SPECIFICATIONS</b>	
Power	2.2kW 9.8A 1PH 230V
Sound Output dB(A)	70
Max Air Flow at l/min	1600
Max Vacuum for Continuous Operation mBar	250
<b>DIMENSIONS</b>	
Height mm	650
Width mm	540
Depth mm	400
Weight kg	41
Shipping Weight kg	63

### RELATED PRODUCTS



PULI-JET Gentle 2.0  
Non-foaming  
Disinfectant



Pulse Cleaner



Antifoaming  
Disinfectant Tablets

**Turbo SMART B 2V with ISO 18 Hydrocyclone | Up to 4 chairs**

Designed with Cattani-pioneered inverter technology, the Turbo SMART B delivers consistent, high-performance suction to 4 chairs. Comes with noise reduction acoustic housing and integrated with ISO 18 Hydrocyclone amalgam retention.

**Details That Matter**

- 3-year full parts and labour warranty
- ISO 18 Hydrocyclone amalgam retention
- Inverter control for performance and energy efficiency
- SMART self-protection in case of functional anomalies
- Modular installation capabilities







**3 YEAR WARRANTY**



**INVERTER CONTROL**



**AMALGAM RETENTION**



**INCLUDES INSTALLATION KIT**

Turbo SMART B 2V	
Item Code	035135
Price Ex GST	\$14,740.00
Price Inc GST	\$16,951.00
<b>SPECIFICATIONS</b>	
Power	2.2kW 9A 1PH 230V
Sound Output dB(A)	70
Max Air Flow at l/min	1600
Max Vacuum for Continuous Operation mBar	250
<b>DIMENSIONS</b>	
Height mm	650
Width mm	540
Depth mm	400
Weight kg	43
Shipping Weight kg	63

**RELATED PRODUCTS**



**PULI-JET Gentle 2.0**  
Non-foaming  
Disinfectant



**Pulse Cleaner**



**Antifoaming Disinfectant Tablets**

**Turbo SMART HP | High-Performance | 338 mbar Vacuum Pressure | 3 Chairs\***

**Raising The Bar**

From dental hygiene to oral surgery, the all-new TURBO SMART HP is the next generation of first-class dental suction to deliver constant peak performance, fully customisable to suit your dental clinic and individual requirements.

**Details That Matter**

- High performance 338 mBar vacuum pressure for highly personalised dental suction performance
- Capability to customise suction power to serve 4 surgeries\*
- Purpose-built for intraoral dental aerosol control
- 70db(A) – improved noise reduction via ventilation technology
- Improved dual-contour blade design for more suction power while using less energy
- Additional vacuum pressure ideal for where dental surgeries have challenging pipework



INDENT ITEM	Turbo SMART HP with ISO 18 Hydrocyclone
Item Code	035145
Price Ex GST	\$19,132.50
Price Inc GST	\$22,002.38
<b>SPECIFICATIONS</b>	
Power	2.7kW 12A 1PH 230V
Sound Output dB(A)	70
Max Air Flow at l/min	1916
Max Vacuum for Continuous Operation mBar	338
<b>DIMENSIONS</b>	
Height mm	765
Width mm	460
Depth mm	350
Weight kg	55

**RELATED PRODUCTS**



**PULI-JET Gentle 2.0**  
Non-foaming  
Disinfectant



**Pulse Cleaner**



**Antifoaming Disinfectant Tablets**

\* 3 chairs as standard, 4 chairs dependent on maximum head setting. For more information, please contact us on +61 3 9484 1120.

# TURBO SMART *TS*

The Next Generation, Reimagined.

Coming soon







## Tandem Micro SMART | Up to 4 chairs

The most compact of our high-performance SMART suction range, installed in parallel to deliver twice the suction performance. Using Cattani pioneered inverter technology, the Tandem Micro SMART is designed to serve 4 chairs.

### Details That Matter

- 3-year full parts and labour warranty
- Installed in parallel with twice the suction
- Inverter control for performance and energy efficiency
- SMART self-protection in case of functional anomalies
- Compatible with Vento frame
- Amalgam retention option available



Model with ISO 6 Hydrocyclone pictured.



3 YEAR WARRANTY



INVERTER CONTROL



AMALGAM RETENTION



INCLUDES INSTALLATION KIT

### Tandem Micro SMART

Item Code	035050TX2
Price Ex GST	\$17,960.00
Price Inc GST	\$20,654.00

#### SPECIFICATIONS

Power	2 x 1.12kW 8A 1PH 230V 2 x 10A power outlets required
Sound Output dB(A)	67-74
Max Air Flow at l/min	1824
Max Vacuum for Continuous Operation mBar	210

#### DIMENSIONS

Height mm	600
Width mm	1030
Depth mm	640
Weight kg	50
Shipping Weight kg	88

#### RELATED PRODUCTS



PULI-JET Gentle 2.0  
Non-foaming  
Disinfectant



Pulse Cleaner



Antifoaming  
Disinfectant Tablets

## Tandem Micro SMART with ISO 6 Hydrocyclone | Up to 4 chairs

The most compact of our high-performance SMART suction range installed in parallel to deliver twice the suction performance. Integrated with ISO 6 Hydrocyclone amalgam retention, the Tandem Micro SMART is designed to serve 4 chairs.

### Details That Matter

- 3-year full parts and labour warranty
- Installed in parallel with twice the suction
- ISO 6 Hydrocyclone amalgam retention
- Inverter control for performance and energy efficiency
- SMART self-protection in case of functional anomalies
- Compatible with Vento frame



#### Tandem Micro SMART with ISO 6 Hydrocyclone

Item Code	035060X2
Price Ex GST	\$19,130.00
Price Inc GST	\$21,999.50

#### SPECIFICATIONS

Power	2 x 1.12kW 8A 1PH 230V 2 x 10A power outlets required
Sound Output dB(A)	67-74
Max Air Flow at l/min	1824
Max Vacuum for Continuous Operation mBar	210

#### DIMENSIONS

Height mm	600
Width mm	1030
Depth mm	640
Weight kg	50
Shipping Weight kg	95

#### RELATED PRODUCTS



PULI-JET Gentle 2.0  
Non-foaming  
Disinfectant



Pulse Cleaner



Antifoaming  
Disinfectant Tablets

## Tandem Turbo SMART A | Up to 5 chairs

Designed with inverter technology, the Turbo SMART A units are installed in parallel to deliver twice the suction performance. This model delivers consistent suction to 5 chairs, with the capability of upgrading to Turbo SMART B to serve 8 chairs.

### Details That Matter

- 3-year full parts and labour warranty
- Installed in parallel with twice the suction
- Capability to upgrade to an 8-chair capacity
- Inverter control for performance and energy efficiency
- SMART self-protection in case of functional anomalies
- Compatible with Vento frame
- Amalgam retention option available



Model with ISO 18 Hydrocyclone pictured.



Tandem Turbo SMART A	
Item Code	035105X2
Price Ex GST	\$25,180.00
Price Inc GST	\$28,957.00
<b>SPECIFICATIONS</b>	
Power	1.5kW 6.5A 1PH 230V 2 x 10A power outlets required
Sound Output dB(A)	72
Max Air Flow at l/min	2860
Max Vacuum for Continuous Operation mBar	210
<b>DIMENSIONS</b>	
Height mm	740
Width mm	1250
Depth mm	760
Weight kg	85
Shipping Weight kg	112

### RELATED PRODUCTS



**PULI-JET Gentle 2.0**  
Non-foaming  
Disinfectant



**Pulse Cleaner**

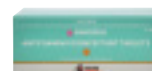

**Antifoaming Disinfectant Tablets**

**Tandem Turbo SMART A with ISO 18 Hydrocyclone | Up to 5 chairs**

Integrated with ISO 18 Hydrocyclone amalgam retention, this model is installed in parallel to deliver twice the suction output. This model delivers high-performance suction to 5 chairs, with the capability of upgrading to Turbo SMART B to serve 8 chairs.

**Details That Matter**

- 3-year full parts and labour warranty
- ISO 18 Hydrocyclone amalgam retention
- Installed in parallel with twice the suction
- Capability to upgrade to an 8-chair capacity
- Inverter control for performance and energy efficiency
- SMART self-protection in case of functional anomalies
- Compatible with Vento frame



**Tandem Turbo SMART A with 2 x ISO 18 Hydrocyclone**

Item Code	035115X2
Price Ex GST	\$26,350.00
Price Inc GST	\$30,302.50

**SPECIFICATIONS**

Power	1.5kW 6.5A 1PH 230V 2 x 10A power outlets required
Sound Output dB(A)	72
Max Air Flow at l/min	2860
Max Vacuum for Continuous Operation mBar	210

**DIMENSIONS**

Height mm	740
Width mm	1250
Depth mm	760
Weight kg	85
Shipping Weight kg	118

**RELATED PRODUCTS**



PULI-JET Gentle 2.0  
Non-foaming  
Disinfectant



Pulse Cleaner



Antifoaming  
Disinfectant Tablets

**Tandem Turbo SMART B | Up to 8 chairs**

Designed with Cattani pioneered inverter technology, the Turbo SMART B units are installed in parallel to deliver twice the suction output. Adjusts performance according to suction demands to serve 8 chairs.

**Details That Matter**

- 3-year full parts and labour warranty
- Installed in parallel with twice the suction
- Inverter control for performance and energy efficiency
- SMART self-protection in case of functional anomalies
- Compatible with Vento frame
- Amalgam retention option available



Model with ISO 18 Hydrocyclone pictured.



**Tandem Turbo SMART B**

Item Code	035105BX2
Price Ex GST	\$27,950.00
Price Inc GST	\$32,142.50

**SPECIFICATIONS**

Power	1.8kW 7.5A 1PH 230V 2 x 10A power outlets required
Sound Output dB(A)	76.7
Max Air Flow at l/min	3500
Max Vacuum for Continuous Operation mBar	210

**DIMENSIONS**

Height mm	740
Width mm	1250
Depth mm	760
Weight kg	85
Shipping Weight kg	112

**RELATED PRODUCTS**



**PULI-JET Gentle 2.0  
Non-foaming  
Disinfectant**



**Pulse Cleaner**



**Antifoaming  
Disinfectant Tablets**

## Tandem Turbo SMART B with ISO 18 Hydrocyclone | Up to 8 chairs

Integrated with ISO 18 Hydrocyclone amalgam retention, the Turbo SMART B units are installed in parallel to deliver twice the suction output. Adjusts performance according to suction demands to serve 8 chairs.

### Details That Matter

- 3-year full parts and labour warranty
- ISO 18 Hydrocyclone amalgam retention
- Installed in parallel with twice the suction
- Capability to upgrade to an 8-chair capacity
- Inverter control for performance and energy efficiency
- SMART self-protection in case of functional anomalies
- Compatible with Vento frame



#### Tandem Turbo SMART B with 2 x ISO 18 Hydrocyclone

Item Code	035115BX2
Price Ex GST	\$29,120.00
Price Inc GST	\$33,488.00

#### SPECIFICATIONS

Power	1.8kW 7.5A 1PH 230V 2 x 10A power outlets required
Sound Output dB(A)	76.7
Max Air Flow at l/min	3500
Max Vacuum for Continuous Operation mBar	210

#### DIMENSIONS

Height mm	740
Width mm	1250
Depth mm	760
Weight kg	85
Shipping Weight kg	118

#### RELATED PRODUCTS



PULI-JET Gentle 2.0  
Non-foaming  
Disinfectant



Pulse Cleaner



Antifoaming  
Disinfectant Tablets

# LARGE PLANT ROOM SOLUTIONS



3 YEAR WARRANTY



INVERTER CONTROL



HYDROCYCLONE AVAILABLE





## **MULTI SMART: DESIGNED FOR THE AUSTRALASIAN REGION**

### **12-20 CHAIRS**

Leading innovation without compromising quality, our Australian technical team collaborated with Cattani Italy to co-engineer the new generation of the Multi SMART range, a more compact 12 – 20 chair solution specifically designed for the Australasian region.

The turn-key solution comes in the following configurations:

- T3 Model – up to 12 chairs.
- T4 Model – up to 16 chairs.
- T5 Model – up to 20 chairs.

### **EASY MAINTENANCE, NO DISRUPTIONS**

Installation of Multi SMART system is a simple process with a modular design that allows easy access for maintenance and HEPA filter upgrade onsite.

Each suction module of the system can be isolated to allow for easy servicing while still delivering uninterrupted suction, keeping the dental site running without disruption.

### **CONSISTENT AND RELIABLE SUCTION**

Multi SMART systems are assembled in parallel, and thanks to inverter technology, provide steady and reliable suction with built-in redundancy.

## **MAXI SMART: THE WORLD'S FIRST INTEGRATED SUCTION UNIT FOR LARGE CLINICS**

### **20-60 CHAIRS**

The Maxi SMART system is the world's first integrated suction unit for large clinics, with the capability to provide a constant level of suction at each individual dental chair.

The system is designed to be installed as a modular system, in pairs, with the potential to serve 60 or more chairs. The system units are built with sequential activation intelligence, according to suction demand. Maxi SMART systems are supplied in kit form, with all interconnecting components necessary for parallel installation.

## **AT CATTANI, WE FOCUS ON INNOVATION.**



**Multi SMART T3 | Up to 12 chairs**

Designed for the Australasian region, our Italian and Australian engineering and technical teams worked closely to develop a new solution that is more compact with no compromise on performance. The Multi SMART T3 is designed to serve up to 12 chairs.

**Details That Matter**

- 3-year full parts and labour warranty
- Compact design where space is a premium
- Simple installation and easy access for servicing
- Allows continuous operation even during maintenance
- Designed with built-in redundancy
- Modular design allowing for easy HEPA upgrade onsite
- Amalgam retention option available



Hydrocyclone model shown.



**INDENT ITEM Multi SMART T3**

Description	Multi SMART T3	Multi SMART T3 with H14 Filtration
Item Code	035105BX3	035105BHX3
Price Ex GST	\$57,830.00	\$62,630.00
Price Inc GST	\$66,504.50	\$72,024.50

**SPECIFICATIONS**

Power	3 x 1.8kW 7.5A 1PH 230V 1x 10A (control panel) Total of 4 x 10A power outlets required	3 x 1.8kW 7.5A 1PH 230V 1x 10A (control panel) Total of 4 x 10A power outlets required
Sound Output dB(A)	78.5	78.5
Max Air Flow at l/min	5100	5100
Max Vacuum for Continuous Operation mBar	210	210

**DIMENSIONS**

Height mm	1280	1280
Width mm*	1000	1000
Depth mm	760	760
Weight kg	150	157
Shipping Weight kg	189	196

\*Dimensions are for frame only. Please allow extra space for installation purposes. Contact our technical team for further information.

**RELATED PRODUCTS**



PULI-JET Gentle 2.0 Non-foaming Disinfectant



Pulse Cleaner



Antifoaming Disinfectant Tablets

## Multi SMART T3 with ISO 18 Hydrocyclone | Up to 12 chairs

Designed for the Australasian region, our Italian and Australian engineering and technical teams worked closely to develop more compact solution. Integrated with ISO 18 Hydrocyclone amalgam retention, the Multi SMART T3 is designed to serve up to 12 chairs.

### Details That Matter

- 3-year full parts and labour warranty
- ISO 18 Hydrocyclone amalgam retention
- Compact design where space is a premium
- Simple installation and easy access for servicing
- Allows continuous operation even during maintenance
- Designed with built-in redundancy
- Modular design allowing for easy HEPA upgrade onsite



INDENT ITEM	Multi SMART T3	
Description	Multi SMART T3 with ISO 18 Hydrocyclone	Multi SMART T3 with ISO 18 Hydrocyclone with H14 Filtration
Item Code	035115BX3	035115BHX3
Price Ex GST	\$61,800.00	\$66,600.00
Price Inc GST	\$71,070.00	\$76,590.00

SPECIFICATIONS		
Power	3 x 1.8kW 7.5A 1PH 230V 1x 10A (control panel) Total of 4 x 10A power outlets required	3 x 1.8kW 7.5A 1PH 230V 1x 10A (control panel) Total of 4 x 10A power outlets required
Sound Output dB(A)	78.5	78.5
Max Air Flow at l/min	5100	5100
Max Vacuum for Continuous Operation mBar	210	210

DIMENSIONS		
Height mm	1280	1280
Width mm*	1000	1000
Depth mm	760	760
Weight kg	184	186
Shipping Weight kg	204	211

\*Dimensions are for frame only. Please allow extra space for installation purposes. Contact our technical team for further information.

### RELATED PRODUCTS



PULI-JET Gentle 2.0  
Non-foaming  
Disinfectant



Pulse Cleaner

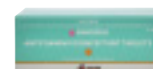

Antifoaming  
Disinfectant Tablets

## Multi SMART T4 | Up to 16 chairs

Designed for the Australasian region, our Italian and Australian engineering and technical teams worked closely to develop a new solution that is more compact with no compromise on performance. The Multi SMART T4 is designed to serve up to 16 chairs.

### Details That Matter

- 3-year full parts and labour warranty
- Compact design where space is a premium
- Simple installation and easy access for servicing
- Allows continuous operation even during maintenance
- Designed with built-in redundancy
- Modular design allowing for easy HEPA upgrade onsite
- Amalgam retention option available



Hydrocyclone model shown.



### INDENT ITEM Multi SMART T4

Description	Multi SMART T4	Multi SMART T4 with H14 Filtration
Item Code	035105BX4	035105BHX4
Price Ex GST	\$75,290.00	\$81,690.00
Price Inc GST	\$86,583.50	\$93,943.50

### SPECIFICATIONS

Power	4 x 1.8kW 7.5A 1PH 230V 1 x 10A (control panel) Total of 5 x 10A power outlets required	4 x 1.8kW 7.5A 1PH 230V 1 x 10A (control panel) Total of 5 x 10A power outlets required
Sound Output dB(A)	79.7	79.7
Max Air Flow at l/min	6800	6800
Max Vacuum for Continuous Operation mBar	210	210

### DIMENSIONS

Height mm	1280	1280
Width mm*	1345	1345
Depth mm	760	760
Weight kg	212	224
Shipping Weight kg	234	254

\*Dimensions are for frame only. Please allow extra space for installation purposes. Contact our technical team for further information.

### RELATED PRODUCTS



PULI-JET Gentle 2.0  
Non-foaming  
Disinfectant



Pulse Cleaner



Antifoaming  
Disinfectant Tablets

## Multi SMART T4 with ISO 18 Hydrocyclone | Up to 16 chairs

Designed for the Australasian region, our Italian and Australian engineering and technical teams worked closely to develop more compact solution. Integrated with ISO 18 Hydrocyclone amalgam retention, the Multi SMART T4 is designed to serve up to 16 chairs.

### Details That Matter

- 3-year full parts and labour warranty
- ISO 18 Hydrocyclone amalgam retention
- Compact design where space is a premium
- Simple installation and easy access for servicing
- Allows continuous operation even during maintenance
- Designed with built-in redundancy
- Modular design allowing for easy HEPA upgrade onsite



INDENT ITEM	Multi SMART T4	
Description	Multi SMART T4 with ISO 18 Hydrocyclone	Multi SMART T4 with ISO 18 Hydrocyclone with H14 Filtration
Item Code	035115BX4	035115BHX4
Price Ex GST	\$80,650.00	\$87,050.00
Price Inc GST	\$92,747.50	\$100,107.50

### RELATED PRODUCTS



PULI-JET Gentle 2.0 Non-foaming Disinfectant



Pulse Cleaner



Antifoaming Disinfectant Tablets

SPECIFICATIONS		
Power	4 x 1.8kW 7.5A 1PH 230V 1 x 10A (control panel) Total of 5 x 10A power outlets required	4 x 1.8kW 7.5A 1PH 230V 1 x 10A (control panel) Total of 5 x 10A power outlets required
Sound Output dB(A)	79.7	79.7
Max Air Flow at l/min	6800	6800
Max Vacuum for Continuous Operation mBar	210	210
DIMENSIONS		
Height mm	1280	1280
Width mm*	1345	1345
Depth mm	760	760
Weight kg	224	249
Shipping Weight kg	254	274

\*Dimensions are for frame only. Please allow extra space for installation purposes. Contact our technical team for further information.

**Multi SMART T5 | Up to 20 chairs**

Designed for the Australasian region, our Italian and Australian engineering and technical teams worked closely to develop a new solution that is more compact with no compromise on performance. The Multi SMART T5 is designed to serve up to 20 chairs.

**Details That Matter**

- 3-year full parts and labour warranty
- Compact design where space is a premium
- Simple installation and easy access for servicing
- Allows continuous operation even during maintenance
- Designed with built-in redundancy
- Modular design allowing for easy HEPA upgrade onsite
- Amalgam retention option available



Hydrocyclone model shown.



**INDENT ITEM Multi SMART T5**

Description	Multi SMART T5	Multi SMART T5 with H14 Filtration
Item Code	035105BX5	035105BHX5
Price Ex GST	\$89,630.00	\$97,630.00
Price Inc GST	\$103,074.50	\$112,274.50

**SPECIFICATIONS**

Power	5 x 1.8kW 7.5A 1PH 230V 1 x 10A (control panel) Total of 6 x 10A power outlets required	5 x 1.8kW 7.5A 1PH 230V 1 x 10A (control panel) Total of 6 x 10A power outlets required
Sound Output dB(A)	80.7	80.7
Max Air Flow at l/min	8500	8500
Max Vacuum for Continuous Operation mBar	210	210

**DIMENSIONS**

Height mm	1280	1280
Width mm*	1690	1690
Depth mm	760	760
Weight kg	265	272
Shipping Weight kg	290	315

\*Dimensions are for frame only. Please allow extra space for installation purposes. Contact our technical team for further information.

**RELATED PRODUCTS**



PULI-JET Gentle 2.0 Non-foaming Disinfectant



Pulse Cleaner



Antifoaming Disinfectant Tablets

## Multi SMART T5 with ISO 18 Hydrocyclone | Up to 20 chairs

Designed for the Australasian region, our Italian and Australian engineering and technical teams worked closely to develop more compact solution. Integrated with ISO 18 Hydrocyclone amalgam retention, the Multi SMART T5 is designed to serve up to 20 chairs.

### Details That Matter

- 3-year full parts and labour warranty
- ISO 18 Hydrocyclone amalgam retention
- Compact design where space is a premium
- Simple installation and easy access for servicing
- Allows continuous operation even during maintenance
- Designed with built-in redundancy
- Modular design allowing for easy HEPA upgrade onsite



INDENT ITEM	Multi SMART T5	
Description	Multi SMART T5 with ISO 18 Hydrocyclone	Multi SMART T5 with ISO 18 Hydrocyclone with H14 Filtration
Item Code	035115BX5	035115BHX5
Price Ex GST	\$96,430.00	\$104,430.00
Price Inc GST	\$110,894.50	\$120,094.50

### RELATED PRODUCTS



PULI-JET Gentle 2.0  
Non-foaming  
Disinfectant



Pulse Cleaner



Antifoaming  
Disinfectant Tablets

SPECIFICATIONS		
Power	5 x 1.8kW 7.5A 1PH 230V 1 x 10A (control panel) Total of 6 x 10A power outlets required	5 x 1.8kW 7.5A 1PH 230V 1 x 10A (control panel) Total of 6 x 10A power outlets required
Sound Output dB(A)	80.7	80.7
Max Air Flow at l/min	8500	8500
Max Vacuum for Continuous Operation mBar	210	210
DIMENSIONS		
Height mm	1280	1280
Width mm*	1690	1690
Depth mm	760	760
Weight kg	265	272
Shipping Weight kg	290	315

\*Dimensions are for frame only. Please allow extra space for installation purposes. Contact our technical team for further information.

## Maxi SMART with ISO 60 Hydrocyclone\* | 15-60 chairs

World's first integrated suction system for large clinics, designed to be installed in parallel to serve up to 60 chairs, with the capacity to serve 15 chairs with a single unit. Integrated with Hydrocyclone amalgam retention, the Maxi SMART is built with sequential activation intelligence, according to suction demand.

### Details That Matter

- 3-year full parts and labour warranty
- Supplied in kit form, ready for parallel installation
- ISO 60 Hydrocyclone amalgam retention
- Sequential activation according to suction demand
- Noise reduction option available

\* Maxi SMART is designed as a modular system to be connected in parallel, not to operate as a single unit. Capacity per unit: 12 chairs if the unit is installed on the same level; 15 chairs if the unit is on the level below.



3 YEAR WARRANTY



INVERTER CONTROL



AMALGAM RETENTION



INCLUDES INSTALLATION KIT

INDENT ITEM	Maxi SMART	
-------------	------------	--

Description	Maxi SMART with ISO 60 Hydrocyclone	Maxi SMART with ISO 60 Hydrocyclone with H14 Filtration
Item Code	035210	035211
Price Ex GST	\$50,933.50	\$54,796.00
Price Inc GST	\$58,573.53	\$63,015.40

#### SPECIFICATIONS

Power	11.8kW 25A 3PH 400V	11.8kW 25A 3PH 400V
Sound Output dB(A)	77	77
Max Air Flow at l/min	5000	5000
Max Vacuum for Continuous Operation mBar	240	240

#### DIMENSIONS

Height mm	1490	1490
Width mm	708	708
Depth mm	1037	1037
Weight kg	215	215
Shipping Weight kg		Upon Request

#### RELATED PRODUCTS



PULI-JET Gentle 2.0 Non-foaming Disinfectant



Pulse Cleaner



Antifoaming Disinfectant Tablets



## Maxi SMART with ISO 60 Hydrocyclone and Acoustic Cover\* | 15-60 chairs

World's first integrated suction system for large clinics, designed to be installed in parallel to serve up to 60 chairs, with the capacity to serve 15 chairs with a single unit. Integrated with Hydrocyclone amalgam retention, with acoustic cover.

### Details That Matter

- 3-year full parts and labour warranty
- Acoustic cover for low noise
- Supplied in kit form, ready for parallel installation
- ISO 60 Hydrocyclone amalgam retention
- Sequential activation according to suction demand

\* Maxi SMART is designed as a modular system to be connected in parallel, not to operate as a single unit. Capacity per unit: 12 chairs if the unit is installed on the same level; 15 chairs if the unit is on the level below.



INDENT ITEM	Maxi SMART	
Description	Maxi SMART with ISO 60 Hydrocyclone and Acoustic Cover	Maxi SMART with ISO 60 Hydrocyclone and Acoustic Cover with H14 Filtration
Item Code	035215	035216
Price Ex GST	\$57,886.00	\$62,675.50
Price Inc GST	\$66,568.90	\$72,076.83
<b>SPECIFICATIONS</b>		
Power	11.8kW 25A 3PH 400V	11.8kW 25A 3PH 400V
Sound Output dB(A)	68	68
Max Air Flow at l/min	5000	5000
Max Vacuum for Continuous Operation mBar	240	240
<b>DIMENSIONS</b>		
Height mm	1490	1490
Width mm	708	708
Depth mm	1037	1037
Weight kg	270	270
Shipping Weight kg		Upon Request

### RELATED PRODUCTS



PULI-JET Gentle 2.0  
Non-foaming  
Disinfectant



Pulse Cleaner



Antifoaming  
Disinfectant Tablets

# COMPACT PLANT ROOM SOLUTIONS



INVERTER  
CONTROL



AMALGAM  
RETENTION

## SPACE IS A PREMIUM

Space is valuable and, in many practices, strictly limited. There can also be issues with noise upsetting staff, patients and even neighbours. Cattani understands that, and provides compact solutions in a variety of configurations and noise-reducing options that can even do away with the need for a plant room entirely.





**Blok-Jet Silent 1 & 2: the self-contained plant solutions | 1-2 and 3-4 chairs**

The Blok-Jet Silent solution is to stack the units inside their own cabinet. Serves up to four chairs and is ultra-quiet, it is an excellent option when noise mitigation is a priority. The cabinet also has a very small footprint and stands on caster wheels, for ease of positioning and service.

**Details That Matter**

- Serves up to four chairs
- Compact – the size of a fridge
- Ultra-quiet
- Mobile – it stands on lockable wheels
- Cabinet doors also lockable
- External display panel shows compressor and suction status
- Arrives assembled to save installation time



Blok-Jet Silent 2 pictured.

INDENT ITEM	Blok-Jet Silent 1	Blok-Jet Silent 2
	Blok-Jet Silent 1 AC200 Compressor & Micro SMART with Hydrocyclone	Blok-Jet Silent 2 AC300 Compressor & Turbo SMART B with Hydrocyclone
Item Code	073500	073525
Price Ex GST	\$28,325.00	\$38,831.00
Price Inc GST	\$32,573.75	\$44,655.65
<b>SPECIFICATIONS</b>		
Compressor	AC200	AC300
Suction	Micro SMART	Turbo SMART B
Sound Output dB(A)	57.5	55
<b>DIMENSIONS</b>		
Height mm	1583	1935
Width mm	727	760
Depth mm	577	650
Weight kg	220	280
Shipping Weight kg		Upon Request

**RELATED PRODUCTS**



PULI-JET Gentle 2.0  
Non-foaming  
Disinfectant



Pulse Cleaner



Antifoaming  
Disinfectant Tablets

## Vento solutions: the ultimate space saver for up to eight chairs

Designed and developed by Cattani Australia, the Vento approach is to stack the suction unit and the compressor on an engineered frame, halving the floor space. This is the perfect plant configuration for practices where space is tight, and a dedicated plant room is a luxury.

Vento can be configured to service up to eight chairs. Units with noise reducing options are also available.

### Vento solutions can incorporate:

- Micro SMART
- Turbo SMART
- Noise-reducing SMART Cube suction units
- Our entire compressor range, including CAD/CAM
- Acoustic compressor hoods [Q Series]
- Amalgam retention



FRAME 1  
Example with AC200 and Turbo SMART with Hydrocyclone



FRAME 2  
Example with AC600 and Tandem Turbo SMART with Hydrocyclone

### How to configure your Vento solution

1. Select your Compressor (pages 10–21)
2. Select your Suction (pages 47-58)
3. Select your Vento frame based on your compressor size (except when choosing Turbo SMART Cube suction system)\*
4. Combine the pricing for your compressor, suction, and Vento frame to determine the overall price of the Vento solution.

	FRAME 1 (Turbo SMART)	FRAME 1B (Turbo SMART Cube)	FRAME 2
Order number	JVT0000	JVTTSC0	JCSTTS
Compatibility	AC100, AC200 & AC300 Series	AC100, AC200 & AC300 Series	Compatible with AC400 & AC600 Series
Price Inc GST	\$2,463.88	\$2,463.88	\$3,014.73
<b>DIMENSIONS</b>			
Height mm	820	820	950
Width mm	695	695	1280
Depth mm	490	610	600
Shipping Weight kg	Upon Request		

\*Frames are only sold as part of a complete Vento configuration. For the individual sale of the frame component, contact your local Business Development Manager.

# CLASSIC SUCTION

## DRY SUCTION: PROVEN CATTANI TECHNOLOGY

### BUILT TO LAST

Cattani dry suction motors deliver high volume airflow with high pressure, even with a large suction tip. Our separators, control panels, and vacuum relief valves are all you need if dry suction is your preferred option.

Cattani dry suction motors are made from quality materials and built to last. The machines are incredibly easy to operate, and the mechanics and circuitry are easy to maintain:

- 1-7 chairs
- Single or three-phase, depending on the unit
- Noise reduction options available
- Units designed to be installed close to the dental unit

## ASPI-JET: MOBILE OR BACKUP SUCTION SYSTEM

### PLUG AND PLAY

If you need a simple, safe, and mobile chairside aspirator for a single chair, Aspi-Jet 6 is for you – just plug it in and turn it on. Aspi-Jet 6 is designed for continuous use and reliable high flow, medium vacuum, and effective air/fluid separation.

### MOBILE RELIABILITY

Aspi-Jet 6 is on wheels for easy transfer from surgery to surgery. It is a handy back-up system and a good option where it is difficult to get plumbing to the dental unit.

Powered by a robust Uni-Jet 75 motor, the Aspi-Jet has a maximum negative pressure of 130 mBar with maximum air flow rate 650 l/min.

The Aspi-Jet range includes plumbed versions in the Aspi-Jet 7, 8 and 9 models that include auto-drain options, all with foam-lined cabinet for quietness.



## MOBILE SUCTION



Aspi-Jet 6 with Bacterial Filter:  
Filter removes solid and biological particles down to 0.01 micron.



Aspi-Jet 6		
Description	Unit without Bacterial Filter	Unit with Bacterial Filter
Item Code	010010	010010B
Price Ex GST	\$5,727.00	\$6,643.50
Price Inc GST	\$6,586.05	\$7,640.03
SPECIFICATIONS		
Sound Output dB(A)	60	60
Max Air Flow at l/min	650	650
Max Vacuum for Continuous Operation mBar	130	130
Tank Size (litres)	4	4
DIMENSIONS		
Height mm	750	750
Width mm	325	325
Depth mm	420	420
STOCKED ITEM		

Manual drain 4 litre canister capacity.



INDENT ITEMS	Aspi-Jet 7	Aspi-Jet 8	Aspi-Jet 9
Item Code	010021	010030	010041
Price Ex GST	\$6,947.50	\$8,652.00	\$9,990.00
Price Inc GST	\$7,989.63	\$9,949.80	\$11,488.50
SPECIFICATIONS			
Sound Output dB(A)	60	60	60
Max Air Flow at l/min	650	650	650
Max Vacuum for Continuous Operation mBar	130	130	130
DIMENSIONS			
Height mm	750	750	750
Width mm	325	325	325
Depth mm	420	420	520
	Automatic drain pump	Automatic drain pump & cup filler	Automatic drain pump, cup filler & spittoon
	Requires plumbing to waste	Requires plumbing to waste Requires water supply	Requires plumbing to waste Requires water & air supply

## Uni-Jet 75 Single Phase | 1 chair



Uni-Jet 75	
Description	Single Phase
Item Code	020322
Price Ex GST	\$1,241.00
Price Inc GST	\$1,427.15

### SPECIFICATIONS

Power	0.42kW 3.1A 1PH
Sound Output dB(A)	62
Max Air Flow at l/min	1250
Max Vacuum for Continuous Operation mBar	130

### DIMENSIONS

Height mm	275
Width mm	232
Depth mm	246

### Accessories

C-020632 Control Panel – H400mm x W300mm x D170mm	\$3,192.40
C-160562 Silencer – L400mm x Dia. 80mm (30mm ports)	\$258.75

## Uni-Jet 75 2V Single Phase | 1 chair



Uni-Jet 75 2V	
Description	Single Phase
Item Code	020370
Price Ex GST	\$2,297.00
Price Inc GST	\$2,641.55

### SPECIFICATIONS

Power	0.7kW 5.2A 1PH
Sound Output dB(A)	64
Max Air Flow at l/min	1330
Max Vacuum for Continuous Operation mBar	270

### DIMENSIONS

Height mm	275
Width mm	246
Depth mm	491

### Accessories

C-020632 Control Panel – H400mm x W300mm x D170mm	\$3,192.40
C-160562 Silencer – L400mm x Dia. 80mm (30mm ports)	\$258.75



**Tecno-Jet Single Phase | 2-3 chairs**



Tecno-Jet	
Description	Single Phase
Item Code	046759
Price Ex GST	\$2,235.00
Price Inc GST	\$2,570.25

SPECIFICATIONS	
Power	0.75kW 5.5A 1PH
Sound Output dB(A)	64
Max Air Flow at l/min	2000
Max Vacuum for Continuous Operation mBar	140

DIMENSIONS	
Height mm	320
Width mm	310
Depth mm	310

Accessories	
C-020631 Control Panel – H400mm x W300mm x D170mm	\$3,192.40
C-160564 Silencer – L400mm x Dia. 160mm (50mm ports)	\$430.68
C-A31080 Vacuum Relief Valve	\$345.58

**Tecno-Jet 2V Single Phase | 2-3 chairs**



INDENT ITEM	
Description	Single Phase
Item Code	020921
Price Ex GST	\$4,676.00
Price Inc GST	\$5,377.40

SPECIFICATIONS	
Power	1.1kW 7.5A 1PH
Sound Output dB(A)	65
Max Air Flow at l/min	2170
Max Vacuum for Continuous Operation mBar	200

DIMENSIONS	
Height mm	320
Width mm	310
Depth mm	550

Accessories	
C-020631 Control Panel – H400mm x W300mm x D170mm	\$3,192.40
C-160564 Silencer – L400mm x Dia. 160mm (50mm ports)	\$430.68
C-A31080 Vacuum Relief Valve	\$345.58

**Flux-Jet 1.1kW Single Phase | 4 chairs**



Flux-Jet 1.1kW	
Description	Single Phase
Item Code	048137
Price Ex GST	\$2,729.50
Price Inc GST	\$3,138.93

**SPECIFICATIONS**

Power	1.1kW 7.6A 1PH
Sound Output dB(A)	68.5
Max Air Flow at l/min	3300
Max Vacuum for Continuous Operation mBar	150

**DIMENSIONS**

Height mm	350
Width mm	340
Depth mm	410

**Accessories**

C-020630 Control Panel – H400mm x W300mm x D170mm	\$3,192.40
C-160564 Silencer – L400mm x Dia. 160mm (50mm ports)	\$430.68
C-400870 Vacuum Relief Valve	\$334.65

**Flux-Jet 2V 3 Phase | 4 chairs**



Flux-Jet 2V	
Description	3 Phase
Item Code	020715
Price Ex GST	\$7,447.00
Price Inc GST	\$8,564.05

**SPECIFICATIONS**

Power	2.2kW 5.2A 3PH
Sound Output dB(A)	72
Max Air Flow at l/min	3300
Max Vacuum for Continuous Operation mBar	230

**DIMENSIONS**

Height mm	350
Width mm	340
Depth mm	590

**Accessories**

C-020630 Control Panel – H400mm x W300mm x D170mm	\$3,192.40
C-160564 Silencer – L400mm x Dia. 160mm (50mm ports)	\$430.68
C-160640 Vacuum Relief Valve	\$772.80

**Medio-Jet Blower 3kW 3 Phase | 7 chairs**



<b>Medio-Jet Blower 3kW</b>	
Description	3 Phase
Item Code	061503
Price Ex GST	\$4,279.50
Price Inc GST	\$4,921.43
<b>SPECIFICATIONS</b>	
Power	3kW 6.8A 3PH
Sound Output dB(A)	76
Max Air Flow at l/min	5000
Max Vacuum for Continuous Operation mBar	230
<b>DIMENSIONS</b>	
Height mm	420
Width mm	400
Depth mm	335
<b>Accessories</b>	
C-021050 Control Panel – H400mm x W300mm x D170mm	\$9,316.15
C-S2S000 Silencer – L265mm x Dia. 90mm (50mm ports)	\$334.65
C-A1549V Vacuum Relief Valve	\$1,115.50

**Uni-Jet 75 in Cover with Control**



<b>INDENT ITEM</b>		<b>Uni-Jet 75</b>
Description	In Cover with Control	
Item Code	020276	
Price Ex GST	\$3,285.50	
Price Inc GST	\$3,778.33	
<b>SPECIFICATIONS</b>		
Power	0.42kW 3.1A 1PH	
Sound Output dB(A)	58	
Max Vacuum for Continuous Operation mBar	130	
<b>DIMENSIONS</b>		
Height mm	330	
Width mm	320	
Depth mm	280	
<b>Accessories</b>		
C-160562 Silencer – L400mm x Dia. 80mm (30mm ports)	\$258.75	



## Continuous Suction Separator

Continuous Suction Separator		
Description	Multi Surgery Unit with Bracket	Multi Surgery Unit without Bracket
Item Code	C0016A0	C0016AB
Price Ex GST	\$2,266.00	\$2,122.00
Price Inc GST	\$2,605.90	\$2,440.30

SPECIFICATIONS		
Power	24V	24V
DIMENSIONS		
Height mm	350	350
Width mm	250	250
Depth mm	100	100

Refer page 92 for classic suction control panels and vacuum relief valves.



## Continuous Suction Separator in Cover

Continuous Suction Separator in Cover		
INDENT ITEM	Single Surgery Unit	Multi Surgery Unit
Description	Single Surgery Unit	Multi Surgery Unit
Item Code	020998	020996
Price Ex GST	\$2,776.00	\$3,285.50
Price Inc GST	\$3,192.40	\$3,778.33

SPECIFICATIONS		
Power	24V	24V
DIMENSIONS		
Height mm	350	350
Width mm	250	250
Depth mm	100	100

Refer page 92 for classic suction control panels and vacuum relief valves.

## SUCTION ACCESSORIES

### Control Panel – Classic Suction

The classic suction control panels include an off delay timer that avoids rapid stop/start of the motor.

Order Number	Dimensions	Model Suited	Price Inc GST
C-020632	Height 400mm Width 300mm Depth 170mm	Uni-Jet 1 Phase	\$3,192.40
C-020631	Height 400mm Width 300mm Depth 170mm	Tecno-Jet 1 Phase	\$3,192.40
C-020630	Height 400mm Width 300mm Depth 170mm	Flux-Jet 1 Phase	\$3,192.40
C-021050	Height 400mm Width 300mm Depth 170mm	All 3 Phase Units	\$9,316.15



### Vacuum Relief Valve – Tecno-Jet

Limits maximum vacuum to not overload the suction motor.

Order Number	Model Suited	Price Inc GST
C-A31080	Tecno-Jet	\$345.58



### Vacuum Relief Valve – Flux-Jet

Limits maximum vacuum to not overload the suction motor.

Order Number	Model Suited	Price Inc GST
C-400870	Flux-Jet	\$334.65



### Vacuum And Heat Relief Valve – Flux-Jet 2V

Limits maximum vacuum to not overload the suction motor.

Order Number	Model Suited	Price Inc GST
C-160640	Flux-Jet 2V	\$772.80



### Vacuum Relief Valve – Medio-Jet 2V

Limits maximum vacuum to not overload the suction motor.

Order Number	Model Suited	Price Inc GST
C-A1549V	Medio-Jet 2V	\$1,115.50



## SUCTION ACCESSORIES

### Silencer for Uni-Jet

Designed to reduce noise by 2dB (A).

Order Number	Dimensions	Pack Qty	Price Inc GST
C-160562	Length 400mm Diameter 80mm (30mm ports)	1	\$258.75



### Silencer for Tecno-Jet and Flux-Jet

Designed to reduce noise by 2dB (A).

Order Number	Dimensions	Pack Qty	Price Inc GST
C-160564	Length 440mm Diameter 160mm (50mm ports)	1	\$430.68



### Silencer for Medio-Jet

Designed to reduce noise by 2dB (A).

Order Number	Dimensions	Pack Qty	Price Inc GST
C-S25000	Length 265mm Diameter 90mm (50mm ports)	1	\$334.65



### Heat Resistant Hose – Suitable for Suction or Exhaust Air

Tubing is sold in metre lengths only unless in full rolls.

Order Number	Internal Diameter	Colour	Price Inc GST
C-H40HR0	40mm	Black	\$380.08 PER M
C-H50HR0	50mm	Black	\$415.73 PER M
C-H60HR0	60mm	Black	\$430.68 PER M
C-H80HR0	80mm	Black	\$533.03 PER M



### Heat Resistant Hose – Suitable for Exhaust Air Only

Tubing is sold in metre lengths only unless in full rolls.

Order Number	Internal Diameter	Colour	Price Inc GST
C-H30EHR	30mm	Black	\$216.20 PER M
C-H40EHR	40mm	Black	\$246.68 PER M
C-H50EHR	50mm	Black	\$266.80 PER M



Available in up to 4 metre lengths

## SUCTION ACCESSORIES

### Genuine Cattani Air Flow Meter

Service technician tool to measure high volume evacuation terminals within the clinic ensuring appropriate levels of suction at each chair.

Order Number	Description	Pack Qty	Price Inc GST
C-A87000	Air flow meter, case & accessories	1	\$1,889.45



### Conversion Switching System

The conversion switching system is a 24V power supply that converts the SMART suction systems 2 wire switching system into a 3 wire system i.e. This is used to provide 24V power to isolation and spittoon drain valves. 30 VA (1.25 Amp). Please ensure that valves that are being powered by this panel do not exceed this rating. High rated power units are available upon request – contact our Cattani Technical Team for more information.

Order Number	Dimensions	Pack Qty	Price Inc GST
D-RZ0000	Height 200mm Width 240mm Depth 95mm	1	\$2,162.00



### Alarm Panel – Suitable with Turbo SMART Systems

The alarm panel is designed to be installed in highly visible area (i.e. reception). The lamp/s illuminate when there is an alarm present on the SMART suction system to alert staff. Includes power supply for lamps and mounting plate. Highly recommended for SMART units installed in parallel.

Order Number	Lamps	Pack Qty	Price Inc GST
D-RA1000	1	1	\$1,830.23
D-RA2000	2	1	\$2,333.35
D-RA3000	3	1	\$1,830.23
D-RA4000	4	1	\$1,563.43





## SUCTION ACCESSORIES

### EP Suction Isolation Valve

This 24V isolation valve is designed for use with all types of suction systems to isolate each chair's suction.

Order Number	Dimensions	Pack Qty	Price Inc GST
C-0039C0	Height 68mm Width 85mm Depth 70mm	1	\$687.13



### Automatic Air Injector Valve – SMART Suction

Automatic air injector valve designed to be installed at the end of the suction line. Allows air to enter the suction line when it is working at a closed head, keeping fluids flowing.

Order Number	Pack Qty	Price Inc GST
C-AAIV00	1	\$2,398.90



### Manual Air Injector Valve – Classic Suction

A manual air injector valve that is designed to be installed at the end of the suction line. Allows air to enter the suction line when it is working at a closed head, keeping fluids flowing.

Order Number	Pack Qty	Price Inc GST
C-1AIV00	1	\$251.85



### Spittoon Drain Valve

Automatic valve that connects the spittoon waste to the suction system. Requires 24V AD/DC supply. Valve is activated when fluid is sensed by the electronic level sensing probes. Valve also activates suction system if not already running.

- Post Box - installation inside the post box.
- Universal - installation in the floor box of dental unit.

Order Number	Dimensions	Pack Qty	Price Inc GST
C-021960	Post Box – Height 180mm Width 47mm Depth 93mm	1	\$1,115.50
C-021974	Universal – Height 180mm Width 110.7mm Depth 100mm	1	\$1,634.73



## Bacterial Filter – Aspi-Jet & Turbo Jet

Filters exhaust suction air prior to releasing to the atmosphere. Recommended when exhaust air has the potential to be released into areas accessible by people. Suitable for Aspi-Jet and Turbo-Jet 1 and 2.

- Removes 99.9% of particles
- Removes bacterial particles down to 0.01 micron
- Odour removal via activated carbon
- 30mm port connection (refer hose connection page for exhaust hoses)
- Filter should be replaced approximately every 12 months



Order Number	Description	Size	Pack Qty	Price Inc GST
CE11024	Filter Housing and Filter	Height 225mm (excludes port protusion) Diameter 140mm	1	\$1,121.25

## HEPA H14 Filter – 1-4 Surgeries

Filters exhaust suction air prior to releasing to the atmosphere. Recommended when exhaust air has the potential to be released into areas accessible by people. Suitable for Turbo SMART, Micro SMART and selected dry suction units, please contact Cattani customer service team for suitable recommendations.

- 99.975% efficiency at 0.3 micron
- Filter should be replaced approximately every 12 months
- Filters 90m3/h
- 63mm port connection (refer hose connection page for suitable exhaust hoses)



Order Number	Description	Size	Pack Qty	Price Inc GST
C-042090	Filter Housing and Filter	Height 230mm Diameter 200mm (excludes port protusion)	1	\$2,416.15
C-042090-KIT	Filter Installation Kit (Turbo SMART & Turbo SMART Cube)	Quick connecton kit for 042090 – includes hose connector, elbow, coupling and reduction bush	1	\$251.85
C-042090-KMS	Filter Installation Kit (Micro SMART & Micro SMART Cube)	Quick connecton kit for 042090 on Micro SMART only – includes hose connector, elbow, coupling and reduction bush.	1	\$300.15
C-160540	Replacement Filter	-	1	\$687.13

## HEPA H14 Filter – 5-8 Surgeries

Filters exhaust suction air prior to releasing to the atmosphere. Recommended when exhaust air has the potential to be released to areas accessible by people. Suitable for Turbo SMART and selected dry suction units, please contact Cattani customer service team for suitable recommendations.

- Filter should be replaced approximately every 12 months
- Filters 188m3/h
- 63mm port connection (refer hose connection page for exhaust hoses)



Order Number	Description	Size	Pack Qty	Price Inc GST
C-042092	Filter Housing and Filter (Tandem Turbo SMART & Tandem Turbo SMART Cube)	Height 460mm Diameter 200mm (excludes port protrusion)	1	\$4,655.20
C-160541	Replacement Filter	-	1	\$1,029.83

## Password Upgrade – Turbo SMART A to B

Increase the capacity of your serviceable dental chairs through the use of the Cattani password upgrade. Simply entered on the keypad of the suction system and you are ready to go. That's SMART, that's Cattani.

Suitable to upgrade:

- Turbo SMART A to Turbo SMART B
- Turbo SMART Cube A to Turbo SMART Cube B

To streamline order process please provide:

1. Serial Number found on I.D. Label on chassis
2. Generated Code found on Control Panel



Order Number	Description	Price Inc GST
035500	Turbo SMART Password Upgrade (A to B)	\$3,001.50

PLEASE NOTE: Refunds/returns are NOT available on password upgrades once ordered from Cattani Italy.

## SUCTION ACCESSORIES

### Micro SMART Series – ISO 6 Hydrocyclone Amalgam Retention Retrofit Kit

Upgrade your Micro SMART to include amalgam retention.

- Flow Rates – Min 0.5 l/min | Max 5.5 l/min
- To streamline order process please provide:
1. Serial Number found on I.D. Label on chassis



Order Number	Description	Pack Qty	Price Inc GST
C-MR6000	Micro SMART Amalgam Retrofit Kit	1	\$1,918.78
C-043382	Micro SMART CUBE Amalgam Retrofit Kit	1	\$1,918.78

### Turbo SMART Series – ISO 18 Hydrocyclone Amalgam Retention Retrofit Kit

Upgrade your Turbo SMART to include amalgam retention.

- Flow Rates – Min 0.5 l/min | Max 18 l/min
- To streamline order process please provide:
1. Serial Number found on I.D. Label on chassis



Order Number	Description	Pack Qty	Price Inc GST
C-1H3C00	Turbo SMART Amalgam Retrofit Kit (Detachable keypad version)	1	\$2,351.18
C-1H0000	Turbo SMART Amalgam Retrofit Kit (Gen 3)	1	\$2,351.18
C-1H3CUB	Turbo SMART CUBE Amalgam Retrofit Kit	1	\$2,955.50

### Replacement Amalgam Containers – Smart Suction

Cattani makes it easy to safely recycle mercury and amalgam through our partner, Ecocycle – Your Specialist Recycler.

Ecocycle helps keep mercury out of landfill and waterways through their state-of-the-art recycling facilities across the nation. Please contact Ecocycle for pricing on replacement containers, pick up and recycling services – 1300 32 62 92 Australia, 0800 73 29 22 New Zealand.



Order Number	Description	Pack Qty
C-043132	ISO 6 Micro SMART and Micro SMART CUBE Amalgam Container	1
C-043135	ISO 18 Turbo SMART and Turbo SMART CUBE Amalgam Container	1
C-043138	ISO 60 Maxi SMART Amalgam Container	1



Contact Ecocycle on  
1300 32 62 92 Australia,  
0800 73 29 22 New Zealand.

## SUCTION SERVICE KITS

### Minor Service Parts

Order Number	Description	Pack Qty	Price Inc GST
C-215956 M-040727	Micro SMART Minor Service Kit – Includes inlet filter o-ring and 4 x 30ml bottle of LUBRI-JET	1	\$8.63 \$46.06
C-211974 M-040727	Turbo SMART Minor Service Kit – Includes inlet filter o-ring and 4 x 30ml bottle of LUBRI-JET	1	\$13.80 \$46.06
C-215986 M-040727	Maxi SMART Minor Service Kit – Includes inlet filter o-ring and 4 x 30ml bottle of LUBRI-JET	1	\$8.63 \$46.06

STOCKED ITEM  
(C-211974 & M040727)

### Intermediate Service Kits

Order Number	Description	Pack Qty	Price Inc GST
C-MR60SK	Micro SMART and Micro SMART CUBE Intermediate Service Kit – ISO 6 Hydrocyclone	1	\$616.98
C-1H00SK	Turbo SMART and Turbo SMART CUBE Intermediate Service Kit – ISO 18 Hydrocyclone	1	\$179.98
C-043390SK	Maxi SMART Intermediate Service Kit – ISO 60 Hydrocyclone	1	\$265.08

STOCKED ITEM  
(C-1H00SK)

### Major Service Kits

Order Number	Description	Price Inc GST
C-MSMSK0	Micro SMART Major Service Kit – Includes: C-025401-SK Separator Kit C-014057-SK Blower Kit and C-MSIHSK Internal Hose Kit	\$1,202.33
C-MSCMSK	Micro SMART CUBE Major Service Kit – Includes: C-025401-SK Separator Kit, C-017500-SK Blower Kit and C-MSCIH0-SK Internal Hose Kit	\$1,080.43
C-TSMSK0	Turbo SMART Major Service Kit – Includes: C-0034MS-3SK Separator Kit, C-1M0000-SK Blower Kit and C-TSIHSK Internal Hose Kit	\$1,120.68
C-TSCMSK	Turbo SMART Cube Major Service Kit – Includes: C-0034MS-3SK Separator Kit, C-014095-SK Blower Kit and C-TSCIH0-SK Internal Hose Kit	\$1,115.50
C-TS2VMSK0	Turbo SMART 2V – Major Service Kit – Includes: C-0034MS-3SK Separator Kit, C-019164-SK Blower Kit and C-TS2VIH-SK Internal Hose Kit	\$1,563.43
C-MAXIMSK	Maxi SMART Major Service Kit – Includes: C-025408-SK Separator Kit, C-091655-SK Blower Kit and C-MXIHSK Internal Hose Kit	\$1,972.25

STOCKED ITEM  
(C-TSMSK0)



Intermediate Service Kit



Separator Major Service Kit



Blower Major Service Kit

## SUCTION SERVICE KITS

### Separator Major Service Kits

Order Number	Description	Pack Qty	Price Inc GST
C-025401SK	Micro SMART and Micro SMART CUBE Separator Major Service Kit	1	\$737.15
C-0034MS3SK	Turbo SMART, Turbo SMART CUBE, Turbo SMART 2V Separator Major Service Kit	1	\$834.33
C-025408SK	Maxi SMART Separator Major Service Kit	1	\$729.10

### Blower Major Service Kits

Order Number	Description	Pack Qty	Price Inc GST
C-014057SK	Micro SMART Blower (U.J. 40) Major Service Kit	1	\$366.28
C-017500SK	Micro SMART CUBE Blower (U.J. 25) Major Service Kit	1	\$358.80
C-1M0000SK	Turbo SMART Blower (U.J. 75) Major Service Kit	1	\$431.83
C-014095SK	Turbo SMART CUBE Blower (U.J.40) Major Service Kit	1	\$278.88
C-019164SK	Turbo SMART 2V Blower (U.J. 75 2V) Major Service Kit	1	\$422.63
C-091655SK	Maxi SMART Blower (M.J.2V) Major Service Kit	1	\$750.38

### Internal Hose Service Kits

Order Number	Description	Pack Qty	Price Inc GST
C-MSIHSK	Micro SMART Internal Hose Kit	1	\$46.58
C-MSCIH0-SK	Micro SMART CUBE Internal Hose Kit	1	\$192.05
C-TSIHSK	Turbo SMART Internal Hose Kit	1	\$128.23
C-TSCIH0-SK	Turbo SMART Cube Internal Hose Kit	1	\$419.75
C-TS2VIH-SK	Turbo SMART 2V Internal Hose Kit	1	\$258.75
C-MXIHSK	Maxi SMART Internal Hose Kit	1	\$392.15

### Major Service Kit (10,000 Hours)

Order Number	Description	Pack Qty	Price Inc GST
C-014000SK	Flux-Jet Blower – Major Service Kit (10,000 Hours)	1	\$596.85
C-A00150SK	Medio-Jet (~3) Blower – Major Service Kit (10,000 Hours)	1	\$396.18
C-006900SK	Tecno-Jet (~1) Blower – Major Service Kit (10,000 Hours)	1	\$539.93
C-0033M0SK	Turbo-Jet 1, Turbo-Jet 1 and 2 – Modular Separator (~1) Major Service Kit (10,000 Hours)	1	\$584.20
C-002300SK	Uni-Jet 75 (~1) Blower – Major Service Kit (10,000 Hours)	1	\$507.73
C-0023V0SK	Uni-Jet 75 2V (~1) Blower – Major Service Kit (10,000 Hours)	1	\$449.08
C-080090SK	Uni-Jet 500 (~3) Blower – Major Service Kit (10,000 Hours)	1	\$2,013.65
C-083067SK	Uni-Jet 1000 (~3) Blower – Major Service Kit (10,000 Hours)	1	\$2,469.63

## SUCTION SERVICE KITS

### Aspi-Jet Mobile Suction – Minor Service Kits (2,000 Hours or 1 Year)

Order Number	Description	Pack Qty	Price Inc GST
C-000600SK	Aspi-Jet – Minor Service Kit	1	\$363.98
C-000600SKB	Aspi-Jet – Minor Service Kit with replacement HEPA H14 Filter	1	\$1,433.48

### SMART Suction Complete Filter (Element and Housing)

Order Number	Description	Pack Qty	Price Inc GST
C-201547	Micro SMART and Micro SMART CUBE	1	\$273.13
C-201544	Turbo SMART, Turbo SMART CUBE and Turbo SMART 2V	1	\$273.13
C-201543	Maxi SMART	1	\$319.13



### Miscellaneous

Order Number	Size	Pack Qty	Price Inc GST
C-182575	Switch for black control panel – Turbo SMART	1	\$116.73
C-186485	Cooling Fan for Turbo SMART and Micro SMART	1	\$473.80

## SUCTION SPARE PARTS

### Capacitors

Order Number	Description	Pack Qty	Price Inc GST
C-189106	10 µF Capacitor Metal Turbo-Jet 1 Range, Turbo-Jet 2 Centrifuge, Aspi-Jet Range and Uni-Jet 75	1	\$125.93
C-189146	20 µF Capacitor C87.0 "UL" Metal With 150mm Cable Turbo-Jet 2 Suction Motor, Tecno-Jet, and Uni-Jet 75 2V	1	\$143.18
C-189147	40 µF Capacitor C87.0 "UL" Metal With 350mm Cable Tecno-Jet 2V and Flux-Jet	1	\$228.28

### Aspi-Jet

Order Number	Size	Pack Qty	Price Inc GST
C-604200	Aspi-Jet Door Handle	1	\$25.88
C-606800	Rubber Elbow	1	\$75.90
C-603941	Canister Top – Aspi-Jet 6	1	\$264.50
C-603600	Castors – Aspi-Jet 6, 7, 8 and 9	1	\$23.58

### Filter – Inline Complete (Turbo-Jet 1 and 2 Modular)

Inline filter with 25mm port connections (includes inlet filter)

Order Number	Description	Pack Qty	Price Inc GST
C-004000	Inlet Filter	1	\$258.75



### Filter Element for Inline Filter

Order Number	Description	Pack Qty	Price Inc GST
C-240317	Filter element	1	\$89.13



### Filter Element for Aspi-Jet Range and Manual Tip Support

Order Number	Description	Pack Qty	Price Inc GST
C-113000	Filter element	1	\$52.33



### Air Filter – Aspi-Jet

Order Number	Description	Pack Qty	Price Inc GST
C-120280	Air filter	1	\$17.83





## SUCTION SPARE PARTS

### Filter for Pneumatic Tip Support (0055)

Order Number	Description	Pack Qty	Price Inc GST
C-551400	Filter element for all pneumatic tip support units	1	\$52.33



### Elbow Hose Connectors

32mm I.D. female coupling to tapered spigot for flexible suction hose.  
25mm (C-3923B0) 30mm (C-3923A0)

Order Number	Description	Pack Qty	Price Inc GST
C-3923B0	25MM	1	\$20.70
C-3923A0	30MM	1	\$20.70



### Straight Hose Connectors

32mm I.D. female coupling to tapered spigot for flexible suction hose.  
20mm (C-3922C0) 25mm (C-3922B0) 30mm (C-3922A0)

Order Number	Description	Pack Qty	Price Inc GST
C-3922C0	20MM	1	\$20.70
C-3922B0	25MM	1	\$20.70
C-3922A0	30MM	1	\$20.70



### Hose Connector for Motorised Suction Isolation Valve

Fits into the motorised suction isolation valve with tapered spigot for flexible suction hose.

Order Number	Description	Pack Qty	Price Inc GST
C-110840	40MM	1	\$29.33



### Coupling Connector – 32mm

32mm O.D. male joining coupling with O-rings

Order Number	Description	Pack Qty	Price Inc GST
C-0040D0	Coupling connector	1	\$52.33



### Mounted Connectors – Flange fitting with Captive Nuts

Order Number	Description	Price Inc GST
C-112800	2 Hose Tip Support (0011b) & Aspi-Jets	\$37.38



### Adaptor for EP Suction Isolating Valve

Reduction bush – glues into 40mm DWV pipe (pipe may need to be heated to fit the bush). Reduces internal diameter to 32mm to accept EP suction isolation valve or coupling connector – 32mm (C-0040D0).

Order Number	Description	Pack Qty	Price Inc GST
F-AEP400	Adaptor	1	\$25.88



# CONSUMABLES

## WHY MAGNOLIA?

As dental care professionals, it is important to apply the appropriate product to your suction equipment to ensure not only the health of your machine, but also as part of your infection control for the safety of staff and patients.



The Magnolia disinfectant range has been specifically developed by Cattani for use with Cattani suction systems. The use of products and procedures outside of manufacturer recommendations can allow bacterial layers to build up. This can impede suction, compromising performance and ultimately damaging machines and systems.

Failure to clean, disinfect or maintain systems methodically as per the manufacturer's recommendations may affect the product warranty.

## MAGNOLIA PRODUCTS

### PULI-JET GENTLE 2.0 – NON-FOAMING DENTAL DISINFECTANT

At Cattani, we offer the PULI-JET Gentle 2.0 dental disinfectant from our Magnolia range, registered as an antimicrobial solution specifically made to disinfect dental medical devices. This is a non-foaming commercial grade disinfectant designed to clean and disinfect the dental suction lines.

### SURFACTANT AND ANTI-SCALING AGENT

PULI-JET Gentle 2.0 also contains surfactant capabilities to help cover more areas of the lines for prolonged disinfection. The other powerful feature is the anti-scaling agent which helps minimise mineral deposits in the pipework and the suction system.

Easy-to-remember disinfecting procedure.

- One single product
- One dilution method
- Once a day
- No alternating schedules
- No shock treatment required

### PULSE CLEANER – MAXIMISES DISINFECTANT ASPIRATION THROUGH THE SUCTION SYSTEM

The Pulse Cleaner automatically aspirates PULI-JET Gentle 2.0 disinfectant solution through the suction system by creating air and fluid turbulence, evenly and widely distributing the disinfectant for the most effective cleaning and protection.

### LUBRI-JET SILICONE LUBRICANT DROPS – EASY CARE FOR O-RINGS AND SEALS

LUBRI-JET is a silicone-based lubricant supplied in a handy dropper bottle, ideal for lubricating rubber O-rings and seals, which increases their lifespan.

Each single pack of LUBRI-JET contains four 30ml bottles.



### ANTIFOAMING DISINFECTANT TABLETS – CONTINUOUS DISINFECTION ALL DAY

Antifoaming Disinfectant Tablets manage the foam that can occur through surgical treatments that have a large amount of dense liquids such as blood, mucus, and thick saliva. The tablet also has a slow-release capability, so that it continuously disinfects the suction lines throughout the entire working day.

Each pack contains 50 tablets, with one required per surgery per day.

### SURGICAL SUCTION TIPS

Cattani Suction Tips are designed to work in harmony with clinical staff and preferred operating techniques. The range covers every clinical situation, from large volume to the very precise, with clinical staff safety and patient comfort always in mind.

Available in high and low-volume sizes to evacuate fluids and airborne particles.

Autoclavable to 135°C. Each pack contains 3 tips.

**AT CATTANI, WE DON'T JUST CLEAN. WE DISINFECT.**

# PULI-JET GENTLE 2.0

## Non-foaming disinfectant for dental suction systems

**PULI-JET Gentle 2.0** is an antimicrobial solution from our *Magnolia* range, specifically made to disinfect dental suction devices, known for its easy-to-remember single dilution disinfecting procedure.

- Phenol free
- Aldehyde free

No alternating schedules, products, or shock treatments are needed.

Each bottle makes 33 doses. Available in 1-litre bottles (30ml of PULI-JET Gentle 2.0 to 2.5 litres of warm water).

### ONE DISINFECTANT, ONE DILUTION, ONCE A DAY



Order Number	Size	Price Inc GST
M060980	Single	\$72.50

STOCKED ITEM



**SUCTION UNIT MAINTENANCE**  
 Point your smartphone camera at this QR code to view our short instructional videos

## CONSUMABLES

### Antifoaming Disinfectant Tablets

Reduces foam that occur through surgical treatments that have a large amount of dense liquids such as blood and mucus, as well as continuously disinfecting the suction lines through the working day.

Each pack contains 50 tablets, with one required per surgery per day.

Order Number	Size	Price Inc GST
M040825	Single	\$160.54

STOCKED ITEM



### Pulse Cleaner

Automatically aspirates PULI-JET Gentle 2.0 disinfectant solution through the suction system by creating air and fluid turbulence, evenly and widely distributing the disinfectant for the most effective cleaning and protection.

Order Number	Size	Price Inc GST
C-040720	Single	\$137.20

STOCKED ITEM



### Reducer Adaptor For Pulse Cleaner

Order Number	Size	Price Inc GST
C-040398	Single	\$37.38



### Plunger For Pulse Cleaner

Order Number	Size	Price Inc GST
C-201846	Single	\$33.93



### LUBRI-JET Silicone Lubricant Drops 30ml

A silicone-based lubricant supplied in a handy dropper bottle, ideal for lubricating rubber O-rings and seals, which increases their lifespan.

Each pack contains 4 x 30ml bottles.

Order Number	Size	Price Inc GST
M-040727	Single Box (4 x 30ml)	\$46.06



### Antifoam Liquid

High efficacy antifoam silicone liquid for larger dental facilities. Reduces foam that occur through surgical treatments that have a large amount of dense liquids such as blood and mucus.

Order Number	Size	Price Inc GST
C-AS1000	Single	\$440.68

# SUCTION ACCESSORIES

## Surgical Suction Tip #9

Dental aspiration tip with a smaller diameter for precise evacuation of fluids from the oral cavity. The design makes it easy to use and ensures effective aspiration during dental procedures. Each pack contains 3 suction tips.

- Autoclavable (Type B) at 134°Celsius, 2.1 bar for 10 minutes
- Reusable for 100 sterilisation cycles
- Sterilise prior to use

Order Number	Size	Pack Qty	Price Inc GST
CT90000	Suits 11mm hose terminal	1	\$47.73

STOCKED ITEM



## Surgical Suction Tip #21

Dental aspiration tip with a smaller diameter for precise evacuation of fluids from the oral cavity. The design makes it easy to use and ensures effective aspiration during dental procedures. Each pack contains 3 suction tips.

- Curved design
- Autoclavable (Type B) at 134°Celsius, 2.1 bar for 10 minutes
- Reusable for 100 sterilisation cycles
- Sterilise prior to use

Order Number	Size	Pack Qty	Price Inc GST
CT21000	Suits 11mm hose terminal	1	\$47.73

STOCKED ITEM



## High Volume Evacuator (HVE) Tip #11

Recommended for aspirators with high airflow and low head. The design of the nebulisation and interceptor makes it easy to use and ensures effective aspiration during dental procedures where evacuation is required. Each pack contains 3 suction tips.

- Autoclavable (Type B) at 134°Celsius, 2.1 bar for 10 minutes
- Reusable for 100 sterilisation cycles
- Sterilise prior to use

Order Number	Size	Pack Qty	Price Inc GST
CT11000	Suits 16mm hose terminal	1	\$47.73



### High Volume Evacuator (HVE) Tip #17

This nebulisation and spray interceptor is ideal for aspirators with moderate airflow. The low noise design makes it easy to use and ensures effective spray interception during dental procedures where high volume evacuation is required. Each pack contains 3 suction tips.

- Quiet
- Angled design
- Autoclavable (Type B) at 134°Celsius, 2.1 bar for 10 minutes
- Reusable for 100 sterilisation cycles
- Sterilise prior to use



Order Number	Size	Pack Qty	Price Inc GST
CT17000	Suits 11mm hose terminal	1	\$47.73

STOCKED ITEM

### High Volume Evacuator (HVE) Tip #20

The HVE #20 tip is recommended for aspirators with high airflow and low head. The curved design is easy to use and ensures effective aspiration and spray interception during dental procedures where high volume evacuation is required. Each pack contains 3 suction tips.

- Curved design
- Autoclavable (Type B) at 134°Celsius, 2.1 bar for 10 minutes
- Reusable for 100 sterilisation cycles
- Sterilise prior to use



Order Number	Size	Pack Qty	Price Inc GST
CT20000	Suits 16mm hose terminal	1	\$47.73

STOCKED ITEM

### High Volume Evacuator (HVE) Tip #22

This nebulisation and spray interceptor is ideal for aspirators with moderate airflow. The curved it is easy to use and ensures effective aspiration and spray interception during dental procedures high volume evacuation is required. Each pack contains 3 suction tips.

- Reduces sound vibration
- Curved design
- Autoclavable (Type B) at 134°Celsius, 2.1 bar for 10 minutes
- Reusable for 100 sterilisation cycles
- Sterilise prior to use



Order Number	Size	Pack Qty	Price Inc GST
CT22000	Suits 16mm hose terminal	1	\$47.73

STOCKED ITEM

## SUCTION ACCESSORIES

### Cleaning Brush for Surgical Suction Tips – Small

Designed for cleaning and scrubbing of dental suction tips. Effectively reaches all parts of the to clean prior to autoclaving. Suitable for small tips (11mm).

Order Number	Size	Pack Qty	Price Inc GST
C-180000	Suits 11mm suction tips	1	\$14.95

STOCKED ITEM

### Cleaning Brush For Surgical Suction and HVE Tips – Large

Designed for cleaning and scrubbing of dental suction tips and high volume evacuator tips. Effectively all parts of the internal surface to clean prior to autoclaving. Suitable for large tips

Order Number	Size	Pack Qty	Price Inc GST
C-190000	Suits 16mm suction tips	1	\$14.95

### Funnel Spittoon

Flexible in its design the Cattani funnel spittoon is designed to fit into both the 11mm and the 16mm hose terminals.

- Autoclavable (Type B) at 134°Celsius, 2.1 bar for 10 minutes
- Reusable for 50 sterilisation cycle

Order Number	Size	Colour	Pack Qty	Price Inc GST
C-040502	Suits 11mm and 16mm hose terminals	White	1	\$37.38

STOCKED ITEM

### Saliva Ejector Adaptor

Designed to suit most saliva ejector tips to fit the 11mm or 16mm hose terminal.

- Autoclavable (Type B) at 134°Celsius, 2.1 bar for 10 minutes
- Reusable for 50 sterilisation cycles

Order Number	Size	Colour	Pack Qty	Price Inc GST
C-150000	Suits 11mm and 16mm hose terminals	Grey	1	\$29.33

STOCKED ITEM

### Tip Reducer

The tip reducer reduces the internal diameter from 16mm to 11mm hose terminals to suit insertion of 11mm suction and high volume evacuator tips. Suitable for use with the Cattani Surgical Suction Tip #9 and High Volume Evacuator (HVE) Tip #17.

- Autoclavable (Type B) at 135°Celsius, 2.1 bar for 10 minutes

Order Number	Size	Colour	Pack Qty	Price Inc GST
C-160000	Reduces diameter from 16 to 11mm	Grey	1	\$8.63

STOCKED ITEM





## SUCTION ACCESSORIES

### Hose Terminal – Small (11mm)

Designed to work with 11mm suction tips and the 11mm high volume evacuation tips.

- Autoclavable (Type B) at 134 °Celsius, 2.1 bar for 10 minutes
- Reusable for 50 sterilisation cycles

Order Number	Size	Colour	Pack Qty	Price Inc GST
C-11015G	11mm	Grey	1	\$81.08
C-11015W	11mm	White	1	\$81.08

STOCKED ITEM  
(C-11015G)



### Hose Terminal – Large (16mm)

Designed to work with 16mm suction tips and the 16mm high volume evacuation tips.

- Autoclavable (Type B) at 134 °Celsius, 2.1 bar for 10 minutes
- Reusable for 50 sterilisation cycles

Order Number	Size	Colour	Pack Qty	Price Inc GST
C-11014G	16mm	Grey	1	\$81.08
C-110140	16mm	Black	1	\$81.08
C-11014W	16mm	White	1	\$81.08

STOCKED ITEM  
(C-11014G)



## SUCTION ACCESSORIES

### Hose End Connector – Small (11mm)

Replacement hose end connector for use with the 11mm Hose Terminal. Also used to connect to manual and pneumatic tip supports.

- Autoclavable (Type B) at 134°Celsius, 2.1 bar for 10 minutes
- Reusable for 50 sterilisation cycles

Order Number	Size	Colour	Pack Qty	Price Inc GST
C-203470	11mm	Grey	1	\$29.33



### Hose End Connector – Large (16mm)

Replacement hose end connector for use with the 16mm Hose Terminal. Also used to connect to manual and pneumatic tip supports.

- Autoclavable (Type B) at 134°Celsius, 2.1 bar for 10 minutes
- Reusable for 50 sterilisation cycles

Order Number	Size	Colour	Pack Qty	Price Inc GST
C-203471	16mm	Grey	1	\$29.33

STOCKED ITEM



### Slide Closer

Replacement slide closer for use with the Hose Terminal.

Order Number	Size	Colour	Pack Qty	Price Inc GST
C-11015F	11mm	Grey	1	\$14.95
C-11014F	16mm	Grey	1	\$14.95

STOCKED ITEM  
(C-11014F)



### Hose Terminal Complete Kit – Small (11mm)

The Cattani Hose Terminal Complete Kit comes ready to connect, simply select your colour and suction hose type. Each kit includes:

- A Hose Terminal
- A Suction Hose (1.5 metres)
- A Hose End Connector

Order Number	Size	Hose Type	Colour	Pack Qty	Price Inc GST
C-11018G	11mm	Spiral	Grey	1	\$216.20
C-11018S00G	11mm	Silicone	Grey	1	\$216.20

Also available in white via special order.



## SUCTION ACCESSORIES

### Hose Terminal Complete Kit – Large (16mm)

The Cattani Hose Terminal Complete Kit comes ready to connect, simply select your colour and suction hose type. Each kit includes:

- A Hose Terminal
- A Suction Hose (1.5 metres)
- A Hose End Connector”

Order Number	Size	Hose Type	Colour	Pack Qty	Price Inc GST
C-11017G	16mm	Spiral	Grey	1	\$216.20
C-11017S00G	16mm	Silicone	Grey	1	\$216.20

STOCKED ITEM  
(C-11017S-00G)

Also available in white via special order.



### Manual Tip Support with Filter

Three hose terminal hanger with manual closure of terminals. Includes manifold with filter, 3 spiral tubes with terminals (1 x 16mm, 2 x 11mm), accessories and additional flat spiral tube. Dimensions without hoses or terminals: Height 118mm x Width 135mm x Depth 105mm.

Order Number	Entry Side	Colour	Pack Qty	Price Inc GST
C-0011BG	Rear	Grey	1	\$1,029.83



### Pneumatic Tip Support with Filter

Two hose terminal hanger with automatic pneumatic closure of terminals. Includes manifold with filter, 2 x silicone tubes with terminals (1 x 11mm and 1 x 16mm), fastening plate, accessories and spiral tube. Dimensions without hoses or terminals: Height 118mm x Width 135mm x Depth 105mm.

Order Number	Colour	Pack Qty	Price Inc GST
C-0055G0	Grey	1	\$1,374.25



## SUCTION ACCESSORIES

### Pneumatic Tip Support with filter and Triplex Holder

Two hose terminal hanger with automatic pneumatic closure of terminals. Also includes triplex holder. Includes an element filter. Dimensions without hoses or terminals: Height 118mm x Width 148mm x Depth 105mm.



Order Number	Colour	Pack Qty	Price Inc GST
C-5528G0	Grey	1	\$1,462.80

### Triplex Syringe Holder

Triplex syringe holder with the flexibility of being either cabinet mounted or fitted to the side of the Cattani Pneumatic Tip Support. Complete with adapters included to cater for various sized syringes.



Order Number	Colour	Pack Qty	Price Inc GST
C-A0028G	Grey	1	\$120.18

### Saliva Ejector Holder

Flexible installation options of being cabinet mounted or fitted to the side of the Cattani Pneumatic Tip Support. Complete with a micro-switch and a range of reducers to cater for various sized hoses.



Order Number	Colour	Pack Qty	Price Inc GST
C-0070G0	Grey	1	\$258.75

### Extension Segment Arm – Manual Tip Support

Extension arm suitable for use with the Cattani Manual Tip Support.

- Double segment arm extends: Minimum 50mm to Maximum 470mm
- Note: Extension lengths do not include the tip support depth.



Order Number	Arm Extension	Pack Qty	Price Inc GST
C-040050	Double	1	\$1,046.50

## SUCTION ACCESSORIES

### Extension Segment Arm – Pneumatic Tip Support

Extension arm suitable for use with the Cattani Pneumatic Tip Support that can be wall or cabinet mounted.

- Single segment arm extends: Maximum 300mm
- Double segment arm extends: Maximum 500mm
- Maximum extension to double segment only

*Note: Extension lengths do not include the tip support depth.*



Order Number	Arm Extension	Pack Qty	Price Inc GST
C-006000	Single	1	\$602.60
C-006100	Double	1	\$945.30

### Suction Hoses – Spiral 11mm

NOTE: FR indicates full roll 25 metres.

Tubing is sold in metre lengths only unless in full rolls.

Order Number	Internal Diameter	Colour	Price Inc GST
C-11013G	11mm	Grey	\$52.33 PER M
C-11013GFR	11mm	Grey	\$797.53 25M ROLL
C-110130	11mm	Black	\$52.33PER M
C-110130FR	11mm	Black	\$797.53 25M ROLL



### Suction Hoses – Spiral 14mm

NOTE: FR indicates full roll 25 metres.

Tubing is sold in metre lengths only unless in full rolls.

Order Number	Internal Diameter	Colour	Price Inc GST
C-H14G00	14mm	Grey	\$52.33 PER M
C-H14GFR	14mm	Grey	\$797.53 25M ROLL
C-H14000	14mm	Black	\$52.33 PER M
C-H14FR0	14mm	Black	\$797.53 25M ROLL



### Suction Hoses – Spiral 16mm

NOTE: FR indicates full roll 25 metres.

Tubing is sold in metre lengths only unless in full rolls.

Order Number	Internal Diameter	Colour	Price Inc GST
C-11012G	16mm	Grey	\$52.33 PER M
C-11012GFR	16mm	Grey	\$797.53 25M ROLL
C-110120	16mm	Black	\$52.33 PER M
C-110120FR	16mm	Black	\$797.53 25M ROLL



## SUCTION ACCESSORIES

### Suction Hoses – Spiral 20mm

NOTE: FR indicates full roll 25 metres.  
Tubing is sold in metre lengths only unless in full rolls.

Order Number	Internal Diameter	Colour	Price Inc GST
C-H20G00	20mm	Grey	\$73.60 PER M
C-H20GFR	20mm	Grey	\$1,158.05 25M ROLL
C-H20000	20mm	Black	\$73.60 PER M
C-H20FR0	20mm	Black	\$1,158.05 25M ROLL



### Suction Hoses – Spiral 25mm

NOTE: FR indicates full roll 25 metres.  
Tubing is sold in metre lengths only unless in full rolls.

Order Number	Internal Diameter	Colour	Price Inc GST
C-H25G00	25mm	Grey	\$73.60 PER M
C-H25GFR	25mm	Grey	\$1,158.05 25M ROLL
C-H25000	25mm	Black	\$73.60 PER M
C-H25FR0	25mm	Black	\$1,158.05 25M ROLL



### Suction Hoses – Spiral 30mm

NOTE: FR indicates full roll 25 metres.  
Tubing is sold in metre lengths only unless in full rolls.

Order Number	Internal Diameter	Colour	Price Inc GST
C-H30G00	30mm	Grey	\$73.60 PER M
C-H30GFR	30mm	Grey	\$1,158.05 25M ROLL
C-H30000	30mm	Black	\$73.60 PER M
C-H30FR0	30mm	Black	\$1,158.05 25M ROLL



### Suction Hoses – Spiral 40mm

NOTE: FR indicates full roll 25 metres.  
Tubing is sold in metre lengths only unless in full rolls.

Order Number	Internal Diameter	Colour	Price Inc GST
C-H40000	40mm	Black	\$87.98 PER M
C-H40FR0	40mm	Black	\$1,504.20 25M ROLL



## SUCTION ACCESSORIES

### Suction Hoses – Spiral 50mm

Tubing is sold in metre lengths only unless in full rolls.

Order Number	Internal Diameter	Colour	Price Inc GST
C-H50000	50mm	Grey	\$90.85 PER M



### Suction Hoses – Spiral 60mm

Tubing is sold in metre lengths only unless in full rolls.

Order Number	Internal Diameter	Colour	Price Inc GST
C-H60000	60mm	Black	\$101.20 PER M



### Suction Hoses – Spiral 80mm

Tubing is sold in metre lengths only unless in full rolls.

Order Number	Internal Diameter	Colour	Price Inc GST
C-H80000	80mm	Black	\$174.80 PER M



### Suction Hoses – Silicone 11mm

NOTE: FR indicates full roll 25 metres.

Tubing is sold in metre lengths only unless in full rolls.

Order Number	Internal Diameter	Colour	Price Inc GST
C-11013S00G	11mm	Grey	\$87.98 PER M
C-11013SGFR	11mm	Grey	\$1,374.25 25M ROLL
C-11013W	11mm	White	\$87.98 PER M
C-11013W-FR	11mm	White	\$1,374.25 25M ROLL



### Suction Hoses – Silicone 16mm

NOTE: FR indicates full roll 25 metres.

Tubing is sold in metre lengths only unless in full rolls.

Order Number	Internal Diameter	Colour	Price Inc GST
C-11012S-00G	16mm	Grey	\$87.98 PER M
C-11012S-GFR	16mm	Grey	\$1,374.25 25M ROLL
C-11012W	16mm	White	\$87.98 PER M
C-11012W-FR	16mm	White	\$1,374.25 25M ROLL



Go to page 93 for heat resistant hoses for suction or exhaust air.

# SELECTION, INSTALLATION, MAINTENANCE AND SERVICE

The pursuit of 100% reliability is what drives Cattani at every level. Our Cattani Blueprints Training Program™ and Cattani After Care Training Program™ cover the essential aspects of selection, installation, ongoing preventative maintenance, and servicing of Cattani equipment for dental clinics.

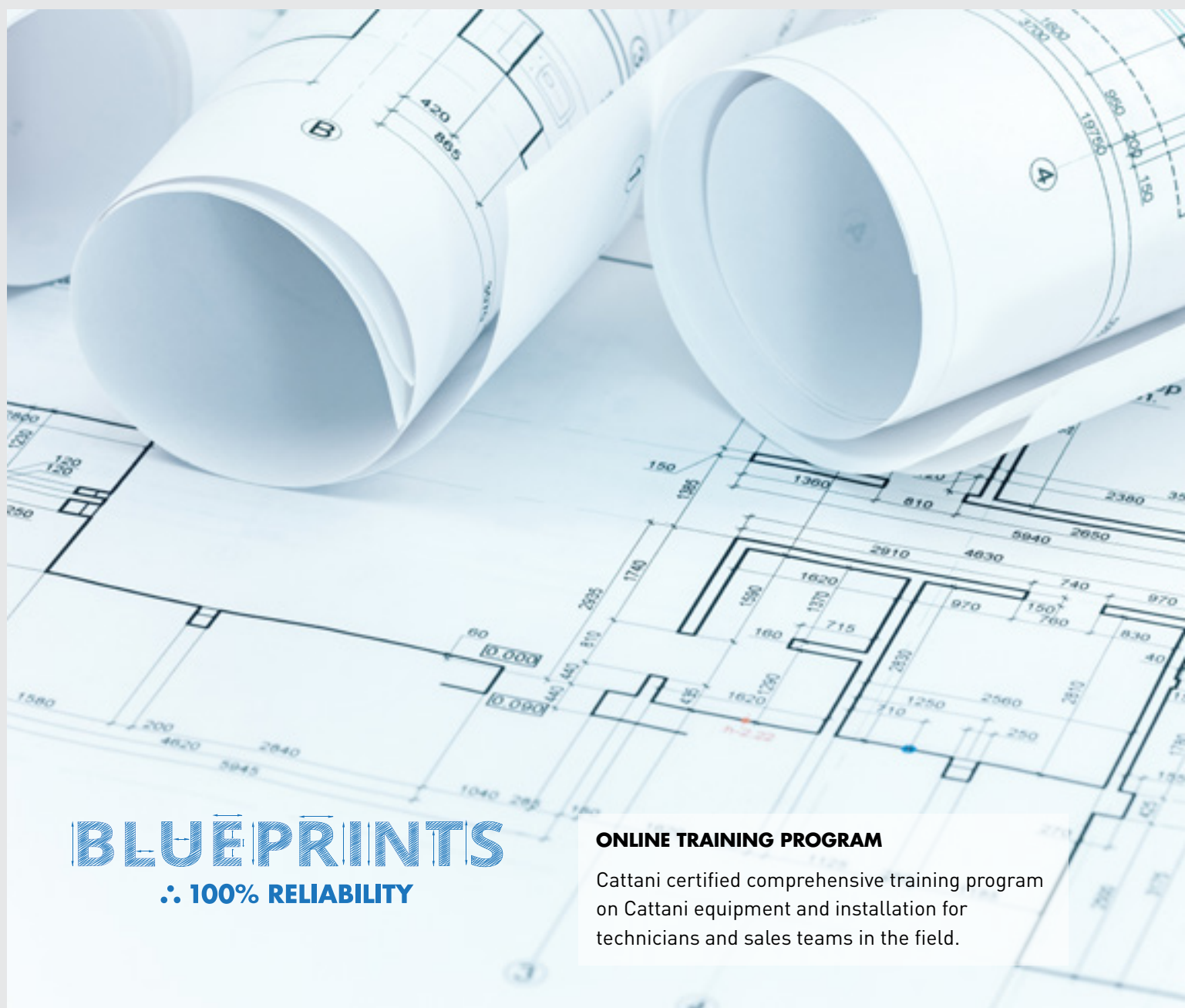

**BLUEPRINTS**  
∴ 100% RELIABILITY

## ONLINE TRAINING PROGRAM

Cattani certified comprehensive training program on Cattani equipment and installation for technicians and sales teams in the field.



# AFTER CARE

∴ 100% RELIABILITY



## AFTER CARE TRAINING PROGRAM

Comprehensive training program for technicians on everything about servicing your equipment.

## AFTER CARE: PROTECT THE POWER BEHIND YOUR PRACTICE

Cattani Australasia wants equipment owners to get maximum benefit, reliability, and life out of their purchase. To that end, we encourage all end users to follow our daily and weekly maintenance guidelines.

We also urge owners to ensure that their equipment is serviced annually using the After Care Service Kits. With annual servicing and scheduled replacement of wear-prone parts you are protecting the power behind your practice. Your suction unit and compressor will then serve you well for its lifetime, preventing untimely and costly breakdowns; and you know the cost from the beginning.



# VENTILATION GUIDELINES – CONTROLLING THE TEMPERATURE IN YOUR PLANT ROOM

## AIR CONDITIONING

Air conditioning is the best way to maintain the stable temperatures your plant room equipment needs for optimal performance. Modern split systems are the most efficient and affordable. And with a dedicated air conditioner in your plant room, no vents are required, so noise emissions are greatly reduced.

The clinic's central air conditioning system must not include the plant room. Instead the room should have its own dedicated air conditioner. Central systems are designed for human comfort and the thermostat is usually located in reception. It cannot sense the temperature in the plant room, so in winter, for example, it would often be heating the room, even though it generates its own heat.

Recommendations for plant room air conditioning:

- 1-4 surgeries – 2.5 kW
- 4-6 surgeries – 3.5 kW
- 6-8 surgeries – 4.5 kW
- 8-10 surgeries – 5.5 kW

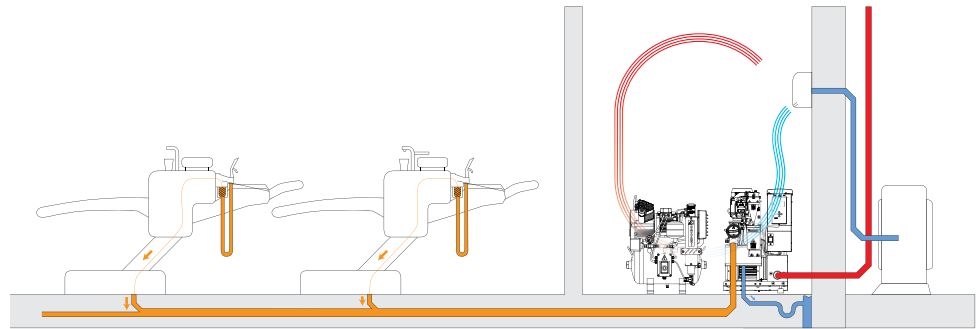

## NOISE REDUCTION OPTIONS

All plant room equipment generates noise, which can irritate dentists, staff and patients. The noise level may also breach council and body corporate regulations. Any noise reduction solution that will cause equipment to overheat is out of the question, so a balance between ventilation and noise reduction needs to be found:

- The plant space can be air conditioned to eliminate the need for vents
- The space may be lined with sound insulation
- Cattani supplies Acoustic Covers for certain models
- Mufflers can be fitted to the suction exhaust outlet
- Fan-forced ventilation vents can be baffled (see below)

## FAN-FORCED VENTILATION

Fan-forced ventilation systems turn over the air in the plant room. Cool air is drawn in while hot air is exhausted via the in-line fan. With this ventilation method we recommend a fan capacity of 150m<sup>3</sup>/hr per 1 kW power rating of your equipment.

There are drawbacks with fan-forced ventilation:

- Noise – the vents needed to allow air to flow through the plant room also allow more noise to escape the room, including extra noise generated by the cooling fans.
- Temperature – an efficient fan-forced ventilation system will only reduce the temperature to 10°C above the incoming air temperature. Also, temperature control is only as consistent as the incoming air temperature.

A simple baffle can reduce noise escaping from vents. Essentially, a box with one end open is placed over the vent. Air can pass through but noise is absorbed. The box can be made of materials similar to cabinet doors and ideally should be lined with sound insulation. Ensure that the open end of the box is large enough so that it does not restrict air flow. Restricting air flow will compromise the efficiency of the ventilation system.

## WHAT YOU NEED TO KNOW

Suction and air supply are the unsung heroes of the dental practice. Without their optimal performance and reliability, work suffers and can even stop, so it is essential that your Cattani equipment is installed correctly.

Your Cattani dealer will discuss with you the various installation options and recommend those that best suit your clinic and environment. The information below is a useful starting point for site requirements, while your installer has the expertise to ensure your set-up produces optimal performance and longevity.

The team at Cattani is also happy to advise you on planning your installation. Call us at +61 3 9484 1120.

### SUCTION SYSTEM ESSENTIALS

The suction piping system uses DWV PVC pipe and connects each dental surgery back to the suction unit in the plant room. The suction unit should be installed on the same floor level or below the level of the dental chairs. It should have a constant fall from the chairs towards the suction unit and cannot include 90° junctions, dips, U-shapes or rises. Termination within the dental surgery is typically at the floor junction box of the dental chair, but is site dependent. The chair manufacturer or installer should be consulted for location details.

Your suction unit will need:

- Suction inlet connection – termination of suction piping that connects to dental surgeries
- Waste connection – sewer drain pipe terminated lower than waste outlet of suction unit
- Exhaust air outlet connection – piping that directs exhaust air to atmosphere outside the building
- Power supply – dedicated electrical power circuit to run the suction unit
- Control switch wiring – switch wiring to connect the dental surgeries to the suction unit

### COMPRESSOR ESSENTIALS

The compressed air piping system is typically copper and connects each dental surgery back to the compressor unit in the plant room. Termination within the dental surgery is typically at the floor junction box of the dental chair, but is site dependent. The chair manufacturer or installer should be consulted for location details.

Your compressor will need:

- Compressed air outlet connection – termination of compressed air piping system that connects to the dental surgeries
- Power supply – dedicated electrical power circuit to run the suction unit
- Waste connection (optional) – sewer connection to allow drainage of compressor condensate

### LOCATION AND ACCESS – WHERE TO POSITION YOUR PLANT ROOM

When designing a new practice, the location of your plant room is an important consideration because proper planning will ensure the most efficient and balanced suction performance. Locating the plant room close to surgeries prevents underperformance caused by excessive pipeline lengths. The plant room must be on the same floor as the dental chairs, or below them. Fluids need to fall to the pump, so if there is a floor below the chairs, like a car park or basement that is accessible and still close to the dental suites above, that location would be ideal for the plant room. Many sites also have air-conditioned plant rooms to protect their investment.

### MAXIMISE YOUR SYSTEM'S PERFORMANCE WITH AN AIR INJECTOR VALVE

Cattani highly recommends the use of an Air Injector Valve with all suction systems. It is best to install one at the time the clinic is constructed but they can also be added later.

Air must flow through the piping in a suction system to help aspirated fluids reach the suction unit. Depending on the site scenario, it is possible that insufficient air will flow through the system. This can lead to fluctuations in performance as fluids pool at the lowest part of the system, with air flow falling below optimal levels. An Air Injector Valve, installed at the end of the pipeline, is an excellent way to compensate for any lack of air volume.

There are two types available:

- **Automatic Air Injector Valve (SMART Suction)** – an automated unit that allows the flow of large volumes of air over short periods. This is an electro-pneumatic valve that is actuated by an electrical signal. It is designed to open only when all chairs have ceased operation. With no air flow required from the chairs, the valve allows a large volume of air to be injected into the system without compromising the performance to the chair.
- **Standard Air Injector Valve (Classic Suction)** – a constantly variable unit that allows the flow of small volumes of air over long periods. It is a simple spring-loaded, vacuum-actuated valve, designed to open at the same time that the chairs are in operation.

If you are building a new clinic, we strongly recommend that you make provision for an Air Injector Valve to be fitted, even if you don't install it straight away. It is much simpler to install an Air Injector Valve to existing services rather than have to add those services later. To provide for an Air Injector Valve, you need to extend the suction pipeline past the chair furthest from the suction unit, terminating the line at a point higher than the main suction pipe line, in an accessible area like a cabinet, ceiling space, void etc. An additional switch cable between this point and the suction unit is also required. Ensure that the pipe is capped if an Air Injector Valve is not being installed immediately. If a system does not have the extra pipe-work from the start, an Air Injector Valve can be retro-fitted by adding it to the floor junction box of the dental chair. However, the noise generated by the aspirated air can be disruptive.

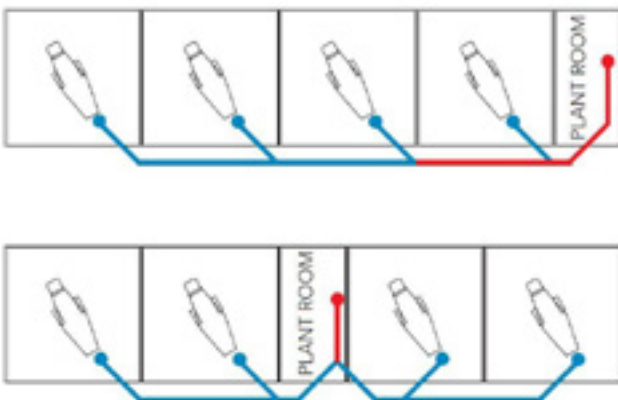

### PIPELINE DESIGN AND LAYOUT

The pipeline needs to facilitate the flow of air and fluids back to the plant room. Pipelines should be designed with a main pipe connected to branches from each dental chair. Large clinics may also require sub-branches. Where possible the piping should take the shortest and straightest route between the plant room and the last dental chair on the line. The diameter of the pipe depends on the number of chairs and the proximity to the plant room: in simple terms, the further from the plant room, the smaller the pipe.

### PIPE SIZE GUIDELINES

Pipe size plays a crucial role in ensuring an even air flow and efficient evacuation of fluids. Suction plumbing requirements based on an average air flow rate of 350l/min per chair are:

- 1-2 chairs – 40mm DWV pipe
- 3-6 chairs – 50mm DWV pipe
- 7-10 chairs – 65mm DWV pipe
- 11-15 chairs – 80mm DWV pipe

### PIPELINE CONFIGURATION GUIDELINES

Bends in the pipeline should never be greater than 45°. If a 90° bend is required, use 2 x 45° bends together in-line. All branches entering a main line must use 45° junctions. Do not use a T-junction when splitting main lines into two branches. Instead, use a 45° Y-junction for the first branch off the main line and 2 x 45° bends for the second.

### PIPELINE RISE AND FALL GUIDELINES

The pipeline should slope constantly towards the suction unit in the plant room. Strictly avoid dips and U-shapes around beams etc to prevent fluids pooling at the lowest point and restricting air flow. If the suction unit is installed on the same floor as the dental chairs, a single vertical rise should be installed just before the unit with the height kept to a minimum. The higher this rise, the greater the risk of fluids creating a wave effect as they try to reach the inlet of the suction unit. This "wave" may cause fluctuating performance at the suction tips.

# AFTER CARE DENTAL CLINIC RESOURCES

## USEFUL DOCUMENTS FOR THE PRACTICE MANAGER



**DOWNLOAD NOW**  
SMART USER MAINTENANCE GUIDE  
FOR CATTANI SMART SUCTION

Point your smartphone camera at this QR code to view.



**DOWNLOAD NOW**  
EXTENDED SHUTDOWN AND RESTART GUIDE  
FOR CATTANI EQUIPMENT

Point your smartphone camera at this QR code to view.

### COMPRESSOR

### SMART SUCTION

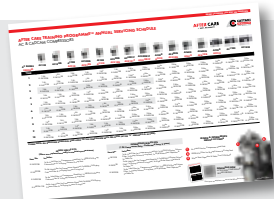

**DOWNLOAD NOW**  
AFTER CARE EQUIPMENT  
SERVICING SCHEDULE

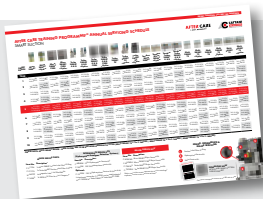

Point your smartphone camera at this QR code to view.



**DOWNLOAD NOW**  
AFTER CARE SCHEDULED  
MAINTENANCE SERVICE RECORD

Point your smartphone camera at this QR code to view.



**Sales and Technical Support:**



**Australia**  
+61 3 9484 1120  
cattani@cattani.com.au  
www.cattani.com.au



**New Zealand**  
0800 68 22 88  
cattani@cattani.co.nz  
www.cattani.co.nz

**Company Address:** 280 Dundas Street, Thornbury VIC 3071, Australia